

JAMESON®

Yeni Nesil Teknoloji...

2023/MART
www.kivilcimelektrik.com.tr

Whatsapp Sipariş Hattı:
0531 727 74 64 

Jameson[®]

GENEL BAKIŞ

1992 yılında Jameson Elektronik olarak kurulan firmamız siz değerli müşterilerimize gösterdiği değer ve kusursuz hizmet daima yenilikçi ve teknolojiyi takip eden hizmet anlayışındadır. Kuruluş tarihimizden bugüne kadar hedeflerimiz kalite, güven, dostluk, müşteri memnuniyetini ön planda tutmaktır. Misyonumuz mükemmeliyetçi kalite anlayışımızla sizi her zaman daha iyiye ve daha pratiğe yönlendirmektedir. Firmamız kurulduğu günden itibaren müşterilerimizin bize olan güveni ve hizmetlerimizin kusursuzluğu ile elektrik-elektronik sektöründe kendine iyi bir yer edinmiştir.

2020 yılından itibaren Jameson markası ile Kıvılcım Elektrik olarak elektrik malzemelerini de bünyesine katan firmamız binlerce çeşidi ile kalite ve yenilikçi anlayışıyla elektrik sektöründe de hizmet etmeye başlamıştır.

İÇİNDEKİLER

KABLO BAĞLARI VE AKSESUARLARI

| | |
|---|----|
| Standart Beyaz Kablo Bağları | 4 |
| Standart Siyah Kablo Bağları | 5 |
| Standart Renkli Kablo Bağları | 6 |
| Ultraviyole Kablo Bağları | 7 |
| Boncuk Kablo Bağları | 7 |
| Paslanmaz Çelik Kablo Bağları | 8 |
| Paslanmaz Çelik Etiket | 8 |
| PVC Kaplı Paslanmaz Çelik Kablo Bağları | 9 |
| Etiketli Kablo Bağları | 10 |
| Açılabilir Kablo Bağları | 10 |
| Distanslı Kablo Bağları | 10 |
| Kartuş Yükseltici | 11 |
| Beton Kroşe | 11 |
| Vidalı Kroşe | 11 |
| Yapışkanlı Kroşeler | 12 |
| Kapama Parçası | 12 |
| Kablo Kelepçesi | 12 |
| Kablo Bağı Etiket Taşıyıcı | 13 |
| Yapışkanlı Pano Etiket Taşıyıcı | 13 |
| Kablo İşaretleme Sistemleri | 13 |
| Kablo Toplama Spiralleri | 14 |

KABLO YÜKSÜKLERİ VE KABLO UÇLARI

| | |
|---|----|
| İzoleli Kablo Yüksükleri Fransız Normu | 16 |
| İzoleli Kablo Yüksükleri Alman Normu | 17 |
| Çift Girişli Kablo Yüksükleri Fransız Normu | 18 |
| Çift Girişli Kablo Yüksükleri Alman Normu | 19 |
| İzolesiz Kablo Yüksükleri | 20 |

KABLO UÇLARI

| | |
|---|----|
| Yuvarlak Tip İzoleli Kablo Uçları | 21 |
| Çatal Tip İzoleli Kablo Uçları | 22 |
| Ek Mufları İzoleli Kablo Uçları | 23 |
| Erkek Terminaller İzoleli Kablo Uçları | 23 |
| Dişi Terminaller İzoleli Kablo Uçları | 23 |
| Dişi Faston Tip İzoleli Kablo Uçları | 24 |
| Tam İzoleli Dişi Faston Tip Kablo Uçları | 24 |
| Tam İzoleli Polyamid Dişi Faston Tip Kablo Uçları | 24 |

| | |
|---|----|
| İğne Tip İzoleli Kablo Uçları | 25 |
| Erkek/Dişi Geri Dönüslü Terminaller | 25 |
| Tam İzoleli Polyamid Bayrak Tip Terminaller | 25 |
| Erkek Faston Tip Kablo Uçları | 26 |
| Vidalı Buat Klemensleri | 26 |
| Hızlı Kablo Ekleme Parçası | 26 |
| İzolesiz Kablo Ucu ve Konnektörleri | 27 |

BAĞLANTI ELEMANLARI

| | |
|------------------------------------|-------|
| SKP-E Ekonomik Tip Kablo Pabucu | 29 |
| SKP-S Standart Tip Kablo Pabucu | 30 |
| Bimetalik Sıkmalı Kablo Pabuçları | 31 |
| Ek Mufları | 32 |
| U Klemens | 33 |
| Monofaze Müşterek W Otomat Barları | 34 |
| Trifaze Müşterek W Otomat Barları | 34 |
| Montaj Rayları | 35 |
| Nötr Topraklama Baralar | 35 |
| Raya Montajlı Priz | 35 |
| Eriyen Bantlar | 36 |
| Pvc İzole Bant | 36 |
| Jks Serisi Kapı Siviçleri | 36 |
| 2 Kutuplu Dağıtıcı Üniteler | 37 |
| 4 Kutuplu Dağıtıcı Üniteler | 38 |
| Tek Kutuplu Dağıtıcı Üniteler | 39-40 |

ÇOK AMAÇLI KLEMENSLER

| | |
|-------------------------|----|
| Geçmeli Buat Klemens | 42 |
| Çok Amaçlı Klemens | 42 |
| Dağıtıcılı Buat Klemens | 43 |

MAKARON ÇEŞİTLERİ ve KABLO TOPLAMA ÇORAPLARI

| | |
|--|-------|
| Isı İle Daralan Siyah Makaronlar | 45 |
| Isı İle Daralan Renkli Makaronlar | 46-47 |
| Isı İle Daralan Makaronlar | 48 |
| İçi Yapışkanlı Boru Tipi Makaronlar | 49 |
| H Class Cam Elyaf Silikon İzoleli Makaronlar | 50 |
| PVC İzoleli Cam Elyaf Makaronlar | 51 |
| Kablo Toplama Çorabı | 52 |

MEKANİK VE HİDROLİK EL ALETLERİ

| | |
|--|-------|
| Yüksük Sıkma Penseleri/Mekanik El Aletleri | 54 |
| Kablo Sıyırıcıları/Mekanik El Aletleri | 56 |
| Kablo Kesme Makasları | 58-60 |
| Kablo Pabucu Mekanik ve Hidrolik Sıkma Penseleri | 59 |

BUTON SERİSİ VE AKSESUARLARI

| | |
|----------------|----|
| Yaylı Butonlar | 62 |
| İkiz Butonlar | 62 |

Ø 22mm Buton Serisi

| | |
|-------------------------------------|----|
| Kalıcı Mandal Butonlar | 63 |
| Kayıcı Kandal Butonlar | 63 |
| Anahtarlı Kalıcı & Kayıcı Butonlar | 63 |
| Joystick Vinç Butonları | 64 |
| Işıklı Kalıcı Mandal Butonlar | 65 |
| 40 mm Kalıcı Mantar Butonlar | 66 |
| 40 mm Kalıcı Anahtarlı Mantar Buton | 66 |
| 40 mm Kayıcı Mantar Butonlar | 66 |
| 40 mm Kalıcı Mantar Butonlar | 66 |
| Buton Aksesuarları | 67 |
| Boş Buton Kutuları | 68 |
| Kutulu Acil Stop Buton | 68 |
| Ø 22mm Voltmetre | 69 |
| Ø 22mm Ampermetre | 69 |
| Ø 22mm Ledli Sinyaller | 70 |
| Ø 16mm Ledli Sinyaller | 70 |
| BA9S Led Ampuller | 71 |
| Metal Ledli Sinyaller | 72 |

Buzzerlar

| | |
|-----------------------|----|
| Ø 22mm Ledli Buzzer | 73 |
| Ø 22mm Sesli Buzzer | 73 |
| Motorlu Sirenler | 73 |
| Elektronik Sirenler | 74 |
| Ø 22mm Potansiyometre | 74 |
| Pano İçi Termostatlar | 74 |

Vinç Kumanda Butonları

| | |
|--|----|
| Plastik Vinç Kumandalar (IP67) | 75 |
| Acil Stoplu Plastik Vinç Kumandalar (IP67) | 75 |
| Ayak Pedalları | 76 |

SWITCH FAN VE FİLTRE ÇEŞİTLERİ

| | |
|-------------------------|-------|
| JLS Serisi Limit Switch | 78-81 |
| JMZ Serisi Mikro Switch | 82-84 |
| JMS Serisi Mikro Switch | 85 |
| Fanlar | 86 |
| Fan Filtreleri | 86 |
| Fan Koruma Telleri | 86 |

Dikkat !

Bu fiyat listesindeki tipografik baskı hatalarından firmamız sorumlu değildir. Firmamız fiyat listesinde yayınlanmış olduğu teknik özellikleri değiştirme, dövizve hammadde artışlarından dolayı meydana gelebilecek fiyat artışlarını hiçbir uyarıda bulunmaksızın fiyat listesine yansıtma hakkına sahiptir.

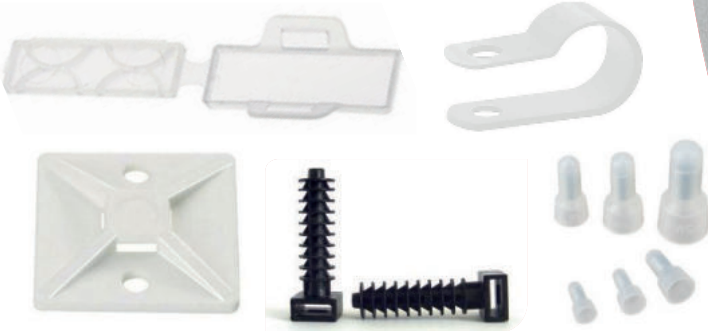

JAMESON®

KABLO BAĞLARI VE AKSESUARLAR

www.kivilcimelektrik.com.tr

STANDART BEYAZ KABLO BAĞLARI

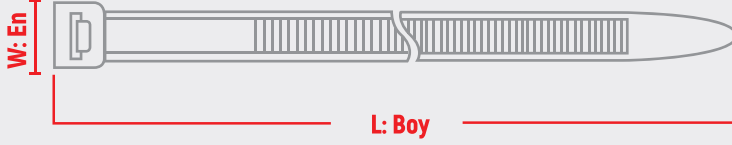

MALZEME: Saf Naylon 6.6 Standart UL
ÇALIŞMA SICAKLIĞI: -40 °C - +85 °C



| Sipariş Kodu | Ürün Kodu | Boyutlar | | Renk | Maksimum Sıkma Çapı (mm) | Açıklama Mukavemeti (kg) | AmbalajAdet | | Birim Fiyat TL / Adet |
|--------------|-------------------|--------------|---------|-------|--------------------------|--------------------------|-------------|--------|-----------------------|
| | | Uzunluk (mm) | En (mm) | | | | Paket | Koli | |
| 3001 | JKB-2510B | 100 | | Beyaz | 20 | | 100 | 50.000 | 0.170 |
| 3002 | JKB-2515B | 150 | 2.5 | Beyaz | 36 | 8 | 100 | 40.000 | 0.265 |
| 3003 | JKB-2520B | 200 | | Beyaz | 52 | | 100 | 30.000 | 0.376 |
| 3004 | JKB 3615B | 150 | | Beyaz | 36 | | 100 | 30.000 | 0.440 |
| 3005 | JKB 3620B | 200 | | Beyaz | 52 | | 100 | 20.000 | 0.572 |
| 3006 | JKB-3625B | 250 | 3.6 | Beyaz | 68 | 18 | 100 | 20.000 | 0.697 |
| 3007 | JKB-3630B | 300 | | Beyaz | 84 | | 100 | 17.000 | 0.872 |
| 3008 | JKB-3637B | 370 | | Beyaz | 106 | | 100 | 12.000 | 1.110 |
| 3009 | JKB-4820B | 200 | | Beyaz | 50 | | 100 | 16.000 | 0.816 |
| 3010 | JKB-4825B | 250 | | Beyaz | 65 | | 100 | 12.000 | 0.995 |
| 3011 | JKB-4830B | 300 | 4.8 | Beyaz | 81 | 22 | 100 | 11.000 | 1.200 |
| 3012 | JKB-4837B | 370 | | Beyaz | 104 | | 100 | 9.000 | 1.400 |
| 3013 | JKB-4843B | 430 | | Beyaz | 123 | | 100 | 7.500 | 1.890 |
| 3014 | JKB-4855B | 550 | | Beyaz | 160 | | 100 | 5.000 | 2.520 |
| 3015 | JKB-7630B | 300 | | Beyaz | 76 | | 100 | 5.000 | 2.400 |
| 3016 | JKB-7637B | 370 | | Beyaz | 102 | | 100 | 4.000 | 2.620 |
| 3017 | JKB-7645B | 430 | 7.6 | Beyaz | 110 | 55 | 100 | 2.500 | 3.050 |
| 3018 | JKB-7655B | 530 | | Beyaz | 140 | | 100 | 2.000 | 4.050 |
| 3019 | JKB-7661B | 610 | | Beyaz | 185 | | 100 | 2.000 | 4.510 |
| 3020 | JKB-7675B | 750 | | Beyaz | 226 | | 100 | 2.000 | 6.200 |
| 3022 | JKB-9710B | 710 | | Beyaz | 190 | | 100 | 2.000 | 6.720 |
| 3023 | JKB-9780B | 780 | | Beyaz | 228 | | 100 | 2.000 | 8.080 |
| 3024 | JKB-9920B | 920 | 9 | Beyaz | 280 | 80 | 100 | 1.000 | 9.300 |
| 3025 | JKB-91020B | 1020 | | Beyaz | 295 | | 100 | 1.000 | 9.750 |
| 3026 | JKB-91220B | 1220 | | Beyaz | 375 | | 100 | 1.000 | 12.100 |

STANDART SİYAH KABLO BAĞLARI

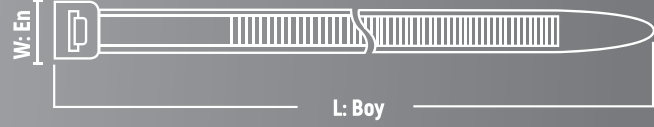
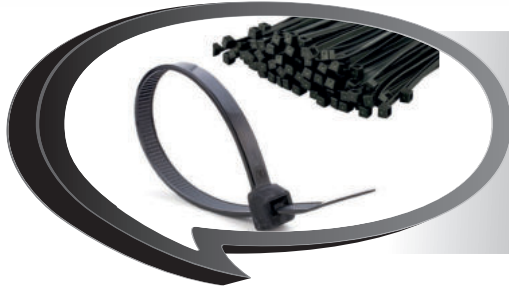

MALZEME: Saf Naylon 6.6 Standart UL
ÇALIŞMA SICAKLIĞI: -40 °C - +85 °C

| Sipariş Kodu | Ürün Kodu | Boyutlar | | Renk | Maksimum Sıkma Çapı (mm) | Açıklama Mukavemeti (kg) | AmbalajAdet | | Birim Fiyat TL / Adet |
|--------------|-------------------|--------------|---------|-------|--------------------------|--------------------------|-------------|--------|-----------------------|
| | | Uzunluk (mm) | En (mm) | | | | Paket | Koli | |
| 3027 | JKB-2510S | 100 | | Siyah | 20 | | 100 | 70.000 | 0.170 |
| 3028 | JKB-2515S | 150 | 2.5 | Siyah | 36 | 8 | 100 | 55.000 | 0.265 |
| 3029 | JKB-2520S | 200 | | Siyah | 52 | | 100 | 32.000 | 0.376 |
| 3030 | JKB-3615S | 150 | | Siyah | 36 | | 100 | 30.000 | 0.440 |
| 3031 | JKB-3620S | 200 | | Siyah | 52 | | 100 | 20.000 | 0.572 |
| 3032 | JKB-3625S | 250 | 3.6 | Siyah | 68 | 18 | 100 | 20.000 | 0.697 |
| 3033 | JKB-3630S | 300 | | Siyah | 84 | | 100 | 17.000 | 0.872 |
| 3034 | JKB-3637S | 370 | | Siyah | 106 | | 100 | 12.000 | 1.110 |
| 3035 | JKB-4820S | 200 | | Siyah | 50 | | 100 | 16.000 | 0.816 |
| 3036 | JKB-4825S | 250 | | Siyah | 65 | | 100 | 12.000 | 0.995 |
| 3037 | JKB-4830S | 300 | 4.8 | Siyah | 81 | 22 | 100 | 11.000 | 1.200 |
| 3038 | JKB-4837S | 370 | | Siyah | 104 | | 100 | 9.000 | 1.400 |
| 3039 | JKB-4843S | 430 | | Siyah | 123 | | 100 | 7.500 | 1.890 |
| 3040 | JKB-4855S | 550 | | Siyah | 160 | | 100 | 5.000 | 2.520 |
| 3041 | JKB-7630S | 300 | | Siyah | 76 | | 100 | 5.000 | 2.400 |
| 3042 | JKB-7637S | 370 | | Siyah | 102 | | 100 | 4.000 | 2.620 |
| 3043 | JKB-7645S | 430 | 7.6 | Siyah | 110 | 55 | 100 | 2.500 | 3.050 |
| 3044 | JKB-7655S | 530 | | Siyah | 140 | | 100 | 2.000 | 4.050 |
| 3045 | JKB-7661S | 610 | | Siyah | 185 | | 100 | 2.000 | 4.510 |
| 3046 | JKB-7675S | 750 | | Siyah | 226 | | 100 | 2.000 | 6.200 |
| 3047 | JKB-9710S | 710 | | Siyah | 190 | | 100 | 2.000 | 6.720 |
| 3048 | JKB-9780S | 780 | | Siyah | 228 | | 100 | 2.000 | 8.080 |
| 3049 | JKB-9920S | 920 | 9 | Siyah | 280 | 80 | 100 | 1.000 | 9.300 |
| 3050 | JKB-91020S | 1020 | | Siyah | 295 | | 100 | 1.000 | 9.750 |
| 3051 | JKB-91220S | 1220 | | Siyah | 375 | | 100 | 1.000 | 12.100 |

STANDART RENKLİ KABLO BAĞLARI

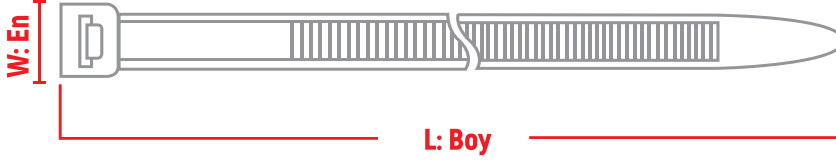

MALZEME: Saf Naylon 6.6 Standart UL

ÇALIŞMA SICAKLIĞI: -40 °C - +85 °C

| Sipariş Kodu | Ürün Kodu | Boyutlar | | Renk | Maksimum Sıkma Çapı (mm) | Açıklama Mukavemeti (kg) | AmbalajAdet | | Birim Fiyat TL / Adet |
|--------------|-------------------|--------------|---------|---------|--------------------------|--------------------------|-------------|--------|-----------------------|
| | | Uzunluk (mm) | En (mm) | | | | Paket | Koli | |
| 3101 | JKB-2510K | 100 | 2.5 | Kırmızı | 20 | 8 | 100 | 70.000 | 0.190 |
| 3102 | JKB-3615K | 150 | | | 36 | | 100 | 30.000 | 0.490 |
| 3103 | JKB-3620K | 200 | 3.6 | Kırmızı | 52 | 18 | 100 | 20.000 | 0.640 |
| 3104 | JKB-3625K | 250 | | | 68 | | 100 | 20.000 | 0.770 |
| 3105 | JKB-3630K | 300 | | | 84 | | 100 | 17.000 | 0.950 |
| 3106 | JKB-4820K | 200 | | | 50 | | 100 | 16.000 | 0.880 |
| 3107 | JKB-4825K | 250 | 4.8 | Kırmızı | 65 | 22 | 100 | 12.000 | 1.080 |
| 3108 | JKB-4830K | 300 | | | 81 | | 100 | 11.000 | 1.320 |
| 3109 | JKB-4837K | 370 | | | 101 | | 100 | 9.000 | 1.540 |
| 3110 | JKB-2510M | 100 | 2.5 | | 20 | 8 | 100 | 70.000 | 0.190 |
| 3111 | JKB-3615M | 150 | | | 36 | | 100 | 30.000 | 0.490 |
| 3112 | JKB-3620M | 200 | 3.6 | | 52 | 18 | 100 | 20.000 | 0.640 |
| 3113 | JKB-3625M | 250 | | | 68 | | 100 | 20.000 | 0.770 |
| 3114 | JKB-3630M | 300 | | Mavi | 84 | | 100 | 17.000 | 0.950 |
| 3115 | JKB-4820M | 200 | | | 50 | | 100 | 16.000 | 0.880 |
| 3116 | JKB-4825M | 250 | 4.8 | | 65 | 22 | 100 | 12.000 | 1.080 |
| 3117 | JKB-4830M | 300 | | | 81 | | 100 | 11.000 | 1.320 |
| 3118 | JKB-4837M | 370 | | | 101 | | 100 | 9.000 | 1.540 |
| 3119 | JKB-2510SR | 100 | 2.5 | | 20 | 8 | 100 | 70.000 | 0.190 |
| 3120 | JKB-3615SR | 150 | | | 36 | | 100 | 30.000 | 0.490 |
| 3121 | JKB-3620SR | 200 | 3.6 | | 52 | 18 | 100 | 20.000 | 0.640 |
| 3122 | JKB-3625SR | 250 | | | 68 | | 100 | 20.000 | 0.770 |
| 3123 | JKB-3630SR | 300 | | Sarı | 84 | | 100 | 17.000 | 0.950 |
| 3124 | JKB-4820SR | 200 | | | 50 | | 100 | 16.000 | 0.880 |
| 3125 | JKB-4825SR | 250 | 4.8 | | 65 | 22 | 100 | 12.000 | 1.080 |
| 3126 | JKB-4830SR | 300 | | | 81 | | 100 | 11.000 | 1.320 |
| 3127 | JKB-4837SR | 370 | | | 104 | | 100 | 9.000 | 1.540 |
| 3128 | JKB-2510Y | 100 | 2.5 | | 20 | 8 | 100 | 70.000 | 0.190 |
| 3129 | JKB-3615Y | 150 | | | 36 | | 100 | 30.000 | 0.490 |
| 3130 | JKB-3620Y | 200 | 3.6 | | 52 | 18 | 100 | 20.000 | 0.640 |
| 3131 | JKB-3625Y | 250 | | | 68 | | 100 | 20.000 | 0.770 |
| 3132 | JKB-3630Y | 300 | | Yeşil | 84 | | 100 | 17.000 | 0.950 |
| 3133 | JKB-4820Y | 200 | | | 50 | | 100 | 16.000 | 0.880 |
| 3134 | JKB-4825Y | 250 | 4.8 | | 65 | 22 | 100 | 12.000 | 1.080 |
| 3135 | JKB-4830Y | 300 | | | 81 | | 100 | 11.000 | 1.320 |
| 3136 | JKB-4837Y | 370 | | | 101 | | 100 | 9.000 | 1.540 |

ULTRAVIOLE KABLO BAĞLARI

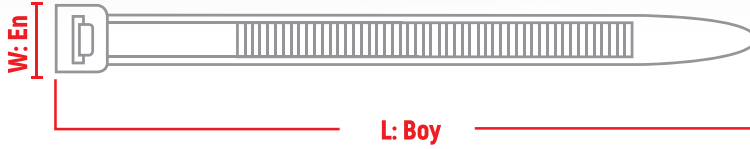

MALZEME: Saf Naylon 6.6 Standart UL
ÇALIŞMA SICAKLIĞI: -40 °C - +85 °C



| Sipariş Kodu | Ürün Kodu | Boyutlar | | Renk | Maksimum Sıkma Çapı (mm) | Açıklama Mukavemeti (kg) | AmbalajAdet | | Birim Fiyat TL / Adet |
|--------------|-------------------|--------------|---------|-------|--------------------------|--------------------------|-------------|--------|-----------------------|
| | | Uzunluk (mm) | En (mm) | | | | Paket | Koli | |
| 3201 | JKB-2510UV | 100 | | Siyah | 20 | | 1.000 | 70.000 | 0.190 |
| 3202 | JKB-2515UV | 150 | 2.5 | Siyah | 36 | 8 | 1.000 | 55.000 | 0.292 |
| 3203 | JKB-2520UV | 200 | | Siyah | 52 | | 1.00 | 32.000 | 0.415 |
| 3204 | JKB-3615UV | 150 | | Siyah | 36 | | 100 | 30.000 | 0.480 |
| 3205 | JKB-3620UV | 200 | | Siyah | 52 | | 100 | 20.000 | 0.622 |
| 3206 | JKB-3625UV | 250 | 3.6 | Siyah | 68 | 18 | 100 | 20.000 | 0.770 |
| 3207 | JKB-3630UV | 300 | | Siyah | 84 | | 100 | 17.000 | 0.950 |
| 3208 | JKB-3637UV | 370 | | Siyah | 50 | | 100 | 16.000 | 1.220 |
| 3209 | JKB-4820UV | 200 | | Siyah | 65 | | 100 | 12.000 | 0.880 |
| 3210 | JKB-4825UV | 250 | | Siyah | 81 | | 100 | 11.000 | 1.082 |
| 3211 | JKB-4830UV | 300 | 4.8 | Siyah | 104 | 22 | 100 | 9.000 | 1.325 |
| 3212 | JKB-4837UV | 370 | | Siyah | 123 | | 100 | 7.500 | 1.550 |
| 3213 | JKB-4843UV | 430 | | Siyah | 76 | | 100 | 5.000 | 2.065 |
| 3214 | JKB-4855UV | 550 | | Siyah | 102 | | 100 | 4.000 | 2.580 |
| 3215 | JKB-7630UV | 300 | | Siyah | 76 | | 100 | 5.000 | 2.700 |
| 3216 | JKB-7637UV | 370 | 7.6 | Siyah | 102 | 55 | 100 | 4.000 | 2.910 |
| 3217 | JKB-7645UV | 430 | | Siyah | 110 | | 100 | 2.500 | 3.340 |
| 3218 | JKB-7653UV | 530 | | Siyah | 140 | | 100 | 2.000 | 4.450 |
| 3219 | JKB-9710UV | 710 | 9 | Siyah | 190 | 80 | 100 | 2.000 | 7.050 |
| 3220 | JKB-9780UV | 780 | | Siyah | 228 | | 100 | 2.000 | 9.630 |

BONCUK KABLO BAĞLARI

| Sipariş Kodu | Ürün Kodu | Boyutlar | | Maksimum Bağlama Çapı (mm) | Minimum Açma Kuvveti (kg) | AmbalajAdet | | Birim Fiyat TL / Adet |
|--------------|------------------|--------------|---------|----------------------------|---------------------------|-------------|--------|-----------------------|
| | | Uzunluk (mm) | En (mm) | | | Paket | Koli | |
| 3228 | JBKB-2510 | 105 | 2 | 25 | 5 | 1.000 | 50.000 | 0.985 |
| 3229 | JBKB-3517 | 165 | 3.5 | 45 | 7 | 500 | 25.000 | 1.335 |

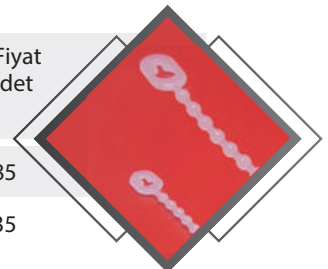

PASLANMAZ ÇELİK KABLO BAĞLARI

| Sipariş Kodu | Ürün Kodu | Boyutlar | | Renk | Maksimum Sıkma Çapı (mm) | Açıklama Mukavemeti (kg) | AmbalajAdet | | Birim Fiyat TL / Adet |
|--------------|-----------------|--------------|---------|-------|--------------------------|--------------------------|-------------|-------|-----------------------|
| | | Uzunluk (mm) | En (mm) | | | | Paket | Koli | |
| 3301 | JMT-4615 | 150 | 4.6 | Metal | 44 | 55 | 100 | 8.000 | 2.85 |
| 3302 | JMT-4620 | 200 | | Metal | 51 | | 100 | 6.000 | 3.15 |
| 3303 | JMT-4625 | 260 | | Metal | 69 | | 100 | 5.000 | 3.45 |
| 3304 | JMT-4630 | 300 | | Metal | 76 | | 100 | 5.000 | 3.70 |
| 3305 | JMT-4635 | 370 | | Metal | 102 | | 100 | 4.000 | 4.13 |
| 3306 | JMT-4650 | 520 | | Metal | 152 | | 100 | 3.000 | 5.30 |
| 3307 | JMT-4670 | 680 | | Metal | 203 | | 100 | 2.000 | 6.25 |
| 3308 | JMT-4685 | 840 | | Metal | 254 | | 100 | 1.000 | 7.62 |
| 3309 | JMT-7920 | 200 | 7.9 | Metal | 50 | 120 | 100 | 5.000 | 4.55 |
| 3310 | JMT-7930 | 300 | | Metal | 75 | | 100 | 4.000 | 5.08 |
| 3311 | JMT-7935 | 370 | | Metal | 102 | | 100 | 3.000 | 5.72 |
| 3312 | JMT-7950 | 520 | | Metal | 152 | | 100 | 2.000 | 7.42 |
| 3313 | JMT-7970 | 680 | | Metal | 203 | | 100 | 2.000 | 9.52 |
| 3314 | JMT-7985 | 840 | | Metal | 224 | | 100 | 1.000 | 10.60 |



Malzeme : 304 Paslanmaz Çelik
Su emilimi : Yok
Alev yürmeme : UL94V-2



PASLANMAZ ÇELİK ETİKET

| Sipariş Kodu | Ürün Kodu | Açıklama | Renk | Boy ve Genişlik (mm) | AmbalajAdet | Birim Fiyat TL / Adet |
|--------------|-----------|------------------------|-------|----------------------|-------------|-----------------------|
| 1351 | MTL PE | Paslanmaz Çelik Etiket | Metal | 19 x 90 | 100 | 6,10 |

Paslanmaz Çelik Kablo Bağları

- Kendiliğinden kilitlenebilir kafa tasarımı, kurulumu hızlandırır ve kablo bağı gövdesi boyunca herhangi bir boyda kilitlemeyi sağlar.
- Güçlü ve dayanıklı kablo bağlama yöntemini temin eder.
- Çok çeşitli iç mekân ve dış mekân uygulama alanlarında kullanılabilir.
- Pürüzsüz yüzeyi ve yuvarlatılmış uçları ile kablunun korunmasını ve çalışan kişinin güvenliğini garanti eder.
- Genel amaçlı uygulamalar için : 304 paslanmaz çelik

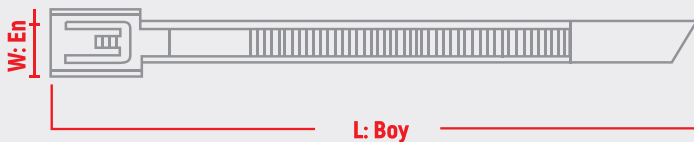

MALZEME: 304 Paslanmaz Çelik
SU EMİLİMİ: Yok
ALEV YÜRME: UL94V-2



PVC KAPLI PASLANMAZ ÇELİK KABLO BAĞLARI

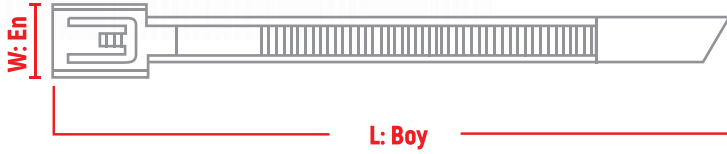

MALZEME: 304 Paslanmaz Çelik
SU EMİLİMİ: Yok
ALEV YÜRME: UL94V-2

| Sipariş Kodu | Ürün Kodu | Boyutlar | | Renk | Maksimum Sıkma Çapı (mm) | Açıklama Mukavemeti (kg) | Paketleme | | Birim Fiyat TL / Adet |
|--------------|------------------|--------------|---------|-------|--------------------------|--------------------------|-----------|-------|-----------------------|
| | | Uzunluk (mm) | En (mm) | | | | Paket | Koli | |
| 3401 | JMT-4615P | 100 | 4.6 | Metal | 44 | 55 | 100 | 8.000 | 4.30 |
| 3402 | JMT-4620P | 200 | | Metal | 51 | | 100 | 6.000 | 4.80 |
| 3403 | JMT-4625P | 260 | | Metal | 69 | | 100 | 5.000 | 5.00 |
| 3404 | JMT-4630P | 300 | | Metal | 76 | | 100 | 5.000 | 5.22 |
| 3405 | JMT-4635P | 370 | | Metal | 102 | | 100 | 4.000 | 6.82 |
| 3406 | JMT-4650P | 520 | | Metal | 152 | | 100 | 3.000 | 8.75 |
| 3407 | JMT-4670P | 680 | | Metal | 203 | | 100 | 2.000 | 11.35 |
| 3408 | JMT-4685P | 840 | | Metal | 254 | | 100 | 1.000 | 13.70 |
| 3409 | JMT-7920P | 200 | 7.9 | Metal | 50 | 120 | 100 | 5.000 | 6.01 |
| 3410 | JMT-7930P | 300 | | Metal | 75 | | 100 | 4.000 | 7.30 |
| 3411 | JMT-7935P | 370 | | Metal | 102 | | 100 | 3.000 | 8.40 |
| 1312 | JMT-7950P | 520 | | Metal | 152 | | 100 | 2.000 | 11.10 |
| 3413 | JMT-7970P | 680 | | Metal | 203 | | 100 | 2.000 | 14.20 |
| 3414 | JMT-7985P | 840 | | Metal | 224 | | 100 | 1.000 | 19.10 |

PVC Kaplı Paslanmaz Çelik Kablo Bağları

- Kendiliğinden kilitlenebilir kafa tasarımı, kurulumu hızlandırır ve kablo bağı gövdesi boyunca herhangi bir boyda kilitlemeyi sağlar.
- Güçlü ve dayanıklı kablo bağlama yöntemini temin eder.
- Çok çeşitli iç mekân ve dış mekân uygulama alanlarında kullanılabilir.
- Pürüzsüz yüzeyi ve yuvarlatılmış uçları ile kablonun korunmasını ve çalışan kişinin güvenliğini garanti eder.
- Şebeke kablolarında en üst düzey desteği sağlar.
- Genel amaçlı uygulamalar için : 304 paslanmaz çelik

ETİKETLİ KABLO BAĞLARI

JEKB-2510Y
L: Boy
25.4 x 8 mm
W: En

JEKB-4819D
L: Boy
28 x 13 mm
W: En

MALZEME:
Saf Naylon 6.6 Standart UL

ÇALIŞMA SICAKLIĞI:
-40 °C - +85 °C

| Sipariş Kodu | Ürün Kodu | Boyutlar | | Renk | Maksimum Sıkma Çapı (mm) | Açılma Mukavemeti (mm) | Ambalaj Adet | | Birim Fiyat TL / Adet |
|--------------|-------------------|--------------|---------|-------|--------------------------|------------------------|--------------|--------|-----------------------|
| | | Uzunluk (mm) | En (mm) | | | | Paket | Koli | |
| 3501 | JEKB-2510Y | 100 | 2.5 | Beyaz | 20 | 8 | 100 | 30.000 | 0.550 |
| 3502 | JEKB-4819D | 190 | 4.8 | Beyaz | 48 | 22 | 100 | 12.000 | 1.300 |

AÇILABİLİR KABLO BAĞLARI

JAKB-7620
L: Boy
W: En

JAKB-7637
L: Boy
W: En

MALZEME:
Saf Naylon 6.6 Standart UL

ÇALIŞMA SICAKLIĞI:
-40 °C - +85 °C

| Sipariş Kodu | Ürün Kodu | Boyutlar | | Renk | Maksimum Sıkma Çapı (mm) | Açılma Mukavemeti (mm) | Ambalaj Adet | | Birim Fiyat TL / Adet |
|--------------|------------------|--------------|---------|-------|--------------------------|------------------------|--------------|-------|-----------------------|
| | | Uzunluk (mm) | En (mm) | | | | Paket | Koli | |
| 3503 | JAKB-7620 | 200 | 7.6 | Beyaz | 50 | 36 | 100 | 5.000 | 1.900 |
| 3504 | JAKB-7637 | 370 | 7.6 | Beyaz | 100 | 36 | 100 | 3.000 | 3.180 |

DİSTANSLI KABLO BAĞI

JDKB-2510
L: Boy
W: En

JDKB-3615
L: Boy
W: En

JDKB-4820
L: Boy
W: En

MALZEME:
Saf Naylon 6.6 Standart UL

ÇALIŞMA SICAKLIĞI:
-40 °C - +85 °C

| Sipariş Kodu | Ürün Kodu | Boyutlar | | Renk | Maksimum Sıkma Çapı (mm) | Açılma Mukavemeti (mm) | Ambalaj Adet | | Birim Fiyat TL / Adet |
|--------------|------------------|--------------|---------|-------|--------------------------|------------------------|--------------|--------|-----------------------|
| | | Uzunluk (mm) | En (mm) | | | | Paket | Koli | |
| 3505 | JDKB-2510 | 100 | 2.5 | Beyaz | 20 | 8 | 100 | 50.000 | 0.530 |
| 3506 | JDKB-3615 | 150 | 3.6 | Beyaz | 35 | 18 | 100 | 30.000 | 0.800 |
| 3507 | JDKB-4820 | 200 | 4.8 | Beyaz | 50 | 22 | 100 | 12.000 | 1.600 |

KARTUŞ YÜKSELTİCİ

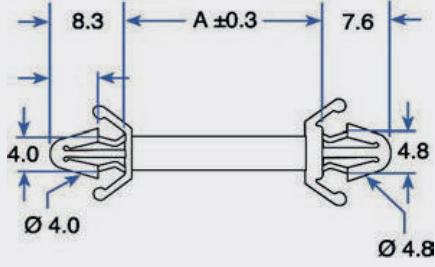

MALZEME:

Saf Naylon 6.6 Standart UL

ÇALIŞMA SICAKLIĞI:

-40 °C «» +85 °C



| Sipariş Kodu | Ürün Kodu | Boyutlar | | Renk | Ambalaj Adet | | Birim Fiyat TL / Adet |
|--------------|----------------|----------|--|-------|--------------|--------|-----------------------|
| | | A | | | Paket | Koli | |
| 3521 | JBS-9A | 9.2 | | Beyaz | 100 | 40.000 | 0.65 |
| 3522 | JBS-13A | 12.6 | | Beyaz | 100 | 35.000 | 0.69 |
| 3523 | JBS-16A | 15.8 | | Beyaz | 100 | 25.000 | 0.75 |

BETON KROŞE

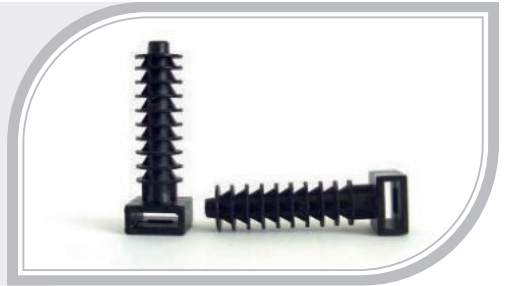
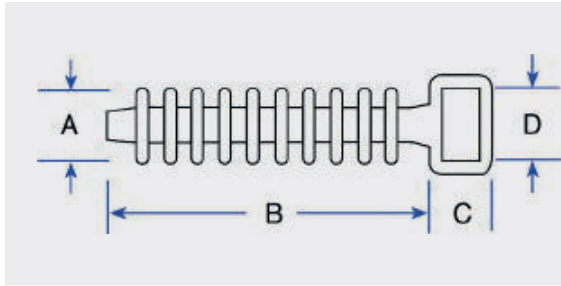

| Sipariş Kodu | Ürün Kodu | Boyutlar | | | | Maksimum Sıkma Çapı (mm) | Renk | Ambalaj Adet | | Birim Fiyat TL / Adet |
|--------------|-------------|----------|------|-----|-----|--------------------------|-------|--------------|-------|-----------------------|
| | | A | B | C | D | | | Paket | Koli | |
| 3524 | JH-2 | 9.5 | 36.0 | 6.0 | 9.5 | ø 9.5 | Siyah | 100 | 5.000 | 0.96 |

VİDALI KROŞE

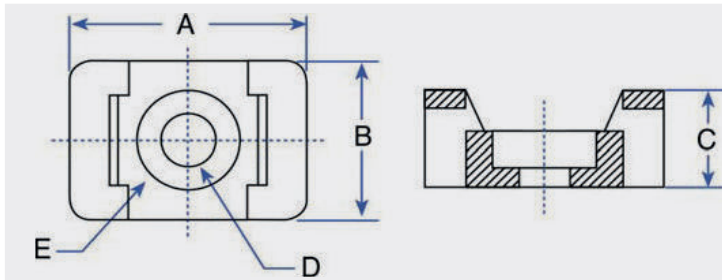

| Sipariş Kodu | Ürün Kodu | Boyutlar | | | | | Maksimum Sıkma Çapı (mm) | Renk | Ambalaj Adet | | Birim Fiyat TL / Adet |
|--------------|----------------|----------|------|-----|-----|------|--------------------------|-------|--------------|-------|-----------------------|
| | | A | B | C | D | E | | | Paket | Koli | |
| 3525 | JKV - 1 | 14.9 | 9.5 | 6.9 | 4.5 | 7.8 | 4.8 | Beyaz | 100 | 5.000 | 0.54 |
| 3526 | JKV - 2 | 22.2 | 15.9 | 9.7 | 6.4 | 12.6 | 7.6 | Beyaz | 100 | 5.000 | 0.78 |

YAPIŞKANLI KROŞELER

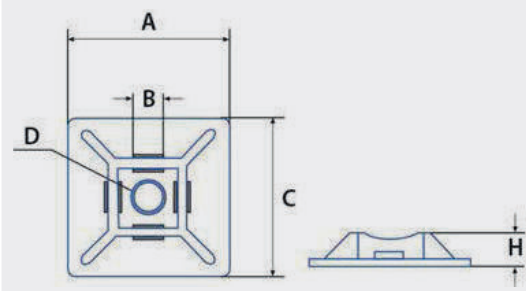

MALZEME:
Saf Naylon 6.6 Standart UL

ÇALIŞMA SICAKLIĞI:
-40 °C «» +85 °C



| Sipariş Kodu | Ürün Kodu | Boyutlar | | | | | Renk | Ambalaj Adet | | Birim Fiyat TL / Adet |
|--------------|------------------|----------|----|-----|-------|-----|-------|--------------|--------|-----------------------|
| | | A | B | C | D | H | | Paket | Koli | |
| 3513 | JYK-1919B | 19 | 19 | 3.6 | ø 3.2 | 4.0 | Beyaz | 100 | 20.000 | 0.74 |
| 3514 | JYK-2828B | 28 | 28 | 4.8 | ø 3.2 | 4.5 | Beyaz | 100 | 5.000 | 1.27 |
| 3515 | JYK-1919S | 19 | 19 | 3.6 | ø 3.2 | 4.0 | Siyah | 100 | 20.000 | 0.74 |
| 3516 | JYK-2828S | 28 | 28 | 4.8 | ø 3.2 | 4.5 | Siyah | 100 | 5.000 | 1.27 |

KAPAMA PARÇASI

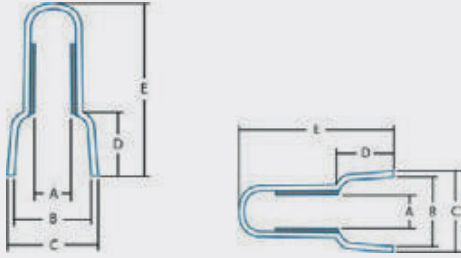

MALZEME:
Saf Naylon 6.6 Standart UL

ÇALIŞMA SICAKLIĞI:
105 °C «» +300°C

MODELİ:
600 Volt Enerjiye Dayabilme



| Sipariş Kodu | Ürün Kodu | Boyutlar | | | | | Renk | Ambalaj Adet | | Birim Fiyat TL / Adet |
|--------------|--------------|----------|----|-----|-------|-----|-------|--------------|--------|-----------------------|
| | | A | B | C | D | H | | Paket | Koli | |
| 3517 | JW-C4 | 19 | 19 | 3.6 | ø 3.2 | 4.0 | Beyaz | 100 | 20.000 | 0.35 |
| 3518 | JW-C5 | 28 | 28 | 4.8 | ø 3.2 | 4.5 | Beyaz | 100 | 9.000 | 0.60 |

KABLO KELEPÇESİ

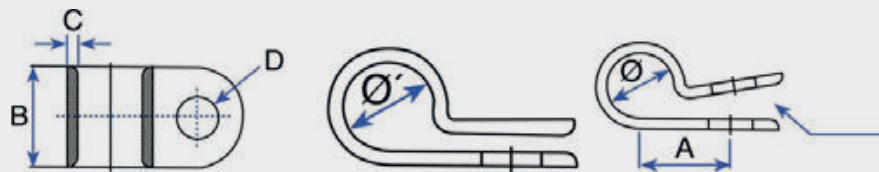

| Sipariş Kodu | Ürün Kodu | Boyutlar | | | | | | Renk | Ambalaj Adet | | Birim Fiyat TL / Adet |
|--------------|---------------|----------|-----|------|-----|------|----|-------|--------------|--------|-----------------------|
| | | Q | Q1 | A | B | C | D | | Paket | Koli | |
| 3519 | JKK-14 | 7.4 | 6.6 | 10.3 | 9.1 | 1.27 | M5 | Beyaz | 100 | 30.000 | 0.55 |
| 3520 | JKK-38 | 10.9 | 9.7 | 11.9 | 9.2 | 1.27 | M5 | Beyaz | 100 | 20.000 | 0.65 |

KABLO BAĞI ETİKET TAŞIYICI

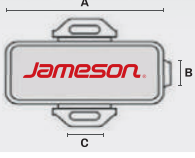

MALZEME:
Polipropilen

ÇALIŞMA SICAKLIĞI:
0°C «» +90 °C



| Sipariş Kodu | Ürün Kodu | Boyutlar | | | Etiket Eni (mm) | Etiket Boyu (mm) | Renk | Ambalaj Adet | | Birim Fiyat TL / Adet |
|--------------|--------------|----------|----|---|-----------------|------------------|-------|--------------|--------|-----------------------|
| | | A | B | C | | | | Paket | Koli | |
| 3527 | JET-1 | 35 | 10 | 8 | 32 | 7 | Beyaz | 100 | 12.500 | 1.40 |
| 3528 | JET-2 | 45 | 20 | 8 | 42 | 17 | Beyaz | 100 | 6.000 | 2.45 |

YAPIŞKANLI PANO ETİKET TAŞIYICI



MALZEME:
ABS Altlık, PS Kapak + Çift Taraflı Bant

ÇALIŞMA SICAKLIĞI:
-40 °C «» +60 °C



| Sipariş Kodu | Ürün Kodu | Boyutlar | | Etiket Eni (mm) | Etiket Boyu (mm) | Renk | Ambalaj Adet | | Birim Fiyat TL / Adet |
|--------------|---------------|----------|----|-----------------|------------------|-------|--------------|--------|-----------------------|
| | | A | B | | | | Paket | Koli | |
| 3529 | JPET-1 | 30 | 17 | 27.5 | 14.4 | Siyah | 100 | 12.000 | 1.52 |
| 3530 | JPET-2 | 50 | 17 | 49 | 15 | Siyah | 100 | 6.000 | 2.06 |
| 3531 | JPET-3 | 75 | 17 | 72 | 15 | Siyah | 100 | 5.000 | 2.80 |

KABLO İŞARETLEME SİSTEMLERİ

| BASKI HARFLERİ | BASKI NUMARASI | EC - 0 | | EC - 1 | | EC - 2 | |
|----------------|----------------|--------------|--------|--------------|--------|--------------|--------|
| | | Sipariş Kodu | Fiyat | Sipariş Kodu | Fiyat | Sipariş Kodu | Fiyat |
| A | 0 | 3601 | | 3623 | | 3645 | |
| B | 1 | 3602 | | 3624 | | 3646 | |
| C | 2 | 3603 | | 3625 | | 3647 | |
| D | 3 | 3604 | | 3626 | | 3648 | |
| E | 4 | 3605 | | 3627 | | 3649 | |
| F | 5 | 3606 | | 3628 | | 3650 | |
| G | 6 | 3607 | | 3629 | | 3651 | |
| H | 7 | 3608 | | 3630 | | 3652 | |
| I | 8 | 3609 | | 3631 | | 3653 | |
| K | 9 | 3610 | | 3632 | | 3654 | |
| L | 9 | 3611 | | 3633 | | 3655 | |
| M | 9 | 3612 | 70 TL. | 3634 | 70 TL. | 3656 | 70 TL. |
| N | 9 | 3613 | | 3635 | | 3657 | |
| O | 9 | 3614 | | 3636 | | 3658 | |
| P | 9 | 3615 | | 3637 | | 3659 | |
| R | 9 | 3616 | | 3638 | | 3660 | |
| S | 9 | 3617 | | 3639 | | 3661 | |
| T | 9 | 3618 | | 3640 | | 3662 | |
| U | 9 | 3619 | | 3641 | | 3663 | |
| V | 9 | 3620 | | 3642 | | 3664 | |
| Y | 9 | 3621 | | 3643 | | 3665 | |
| Z | 9 | 3622 | | 3644 | | 3666 | |



KABLO TOPLAMA SİRALLERİ



| Sipariş Kodu | Ürün Kodu | O.D. | T | W | Kablo Kesit (mm ²) | Renk | Paket Miktarı (Mt) | Koli Miktarı (Mt) | Birim Fiyat TL / Adet |
|--------------|---------------------|------|------|------|--------------------------------|-------|--------------------|-------------------|-----------------------|
| 3701 | JHS-6 (No1) | 6 | 0.60 | 7.4 | 2.5 - 15 | Beyaz | 10 | 1.000 | 4.65 |
| 3702 | JHS-8 (No2) | 8 | 0.75 | 12 | 6 - 30 | Beyaz | 10 | 800 | 5.00 |
| 3703 | JHS-10 (No3) | 10 | 0.80 | 12.3 | 7.5 - 30 | Beyaz | 10 | 500 | 5.90 |
| 3704 | JHS-12 (No4) | 12 | 0.85 | 15 | 9 - 32 | Beyaz | 10 | 400 | 8.90 |
| 3705 | JHS-15 (No5) | 15 | 1.00 | 15.5 | 12 - 35 | Beyaz | 10 | 250 | 10.10 |

MALZEME: PE

Esnek yapısı sayesinde kabloların düzenlemesine yardımcı olur
Güçlü yapısı sayesinde tekrar kullanım için uygundur



YENİ ÜRÜN

| Sipariş Kodu | Ürün Kodu | ÜRÜN AÇIKLAMASI | İÇ ÖLÇÜ | DIŞ ÖLÇÜ | Renk | RULO METRAJ | Birim Fiyat TL / Adet |
|--------------|----------------|-----------------------------|---------|----------|-------|-------------|-----------------------|
| 7732 | JKTS-1 | 20 LİK KABLO TOPLAMA SİRALİ | 16MM | 18MM | Gri | 1.5MT | 80.00 |
| 7734 | JKTS-2 | 20 LİK KABLO TOPLAMA SİRALİ | 16MM | 18MM | Siyah | 1.5MT | 76.00 |
| 7735 | JKTS-3 | 25 LİK KABLO TOPLAMA SİRALİ | 22MM | 25MM | Gri | 1.5MT | 94.00 |
| 7736 | JKTS-4 | 25 LİK KABLO TOPLAMA SİRALİ | 22MM | 25MM | Siyah | 1.5MT | 88.00 |
| 7737 | JKTS-5 | 30 LUK KABLO TOPLAMA SİRALİ | 27MM | 30MM | Gri | 1.5MT | 110.00 |
| 7738 | JKTS-6 | 30 LUK KABLO TOPLAMA SİRALİ | 27MM | 30MM | Siyah | 1.5MT | 100.00 |
| 7739 | JKTS-7 | 20 LİK KABLO TOPLAMA SİRALİ | 16MM | 18MM | Gri | 25MT | 25.00 |
| 7740 | JKTS-8 | 20 LİK KABLO TOPLAMA SİRALİ | 16MM | 18MM | Siyah | 25MT | 22.85 |
| 7741 | JKTS-9 | 25 LİK KABLO TOPLAMA SİRALİ | 22MM | 25MM | Gri | 20MT | 32.00 |
| 7742 | JKTS-10 | 25 LİK KABLO TOPLAMA SİRALİ | 22MM | 25MM | Siyah | 20MT | 28.85 |
| 7742 | JKTS-11 | 30 LUK KABLO TOPLAMA SİRALİ | 27MM | 30MM | Gri | 15MT | 38.85 |
| 7743 | JKTS-12 | 30 LUK KABLO TOPLAMA SİRALİ | 27MM | 30MM | Siyah | 15MT | 35.75 |



JAMESON[®]

**KABLO
YÜKSÜKLERİ
TEK VE ÇİFT GİRİŞLİ**

www.kivilcimelektrik.com.tr

İZOLELİ KABLO YÜKSÜKLERİ FRANSIZ NORMU

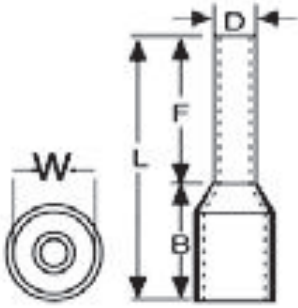

STANDART: DIN 46228

MALZEME: Bakır, Kalay Kaplı

İZOLASYON: Naylon

ÇALIŞMA SICAKLIĞI:
Maksimum 105 ° 600 volt Arası



| Sipariş Kodu | Ürün Kodu | Renk | Kablo Kesit (mm ²) | Ebatlar (mm) | | | | | Kutuj Adet | Birim Fiyat TL / Adet |
|--------------|-----------------|---------|--------------------------------|--------------|------|------|------|------|------------|-----------------------|
| | | | | F | L | W | B | D | | |
| 3801 | JYF-0.25 | Menekşe | 0.25 mm ² | 8.0 | 12.0 | 1.9 | 4.4 | 1.1 | 1.000 | 0.370 |
| 3802 | JYF-0.34 | Pembe | 0.34 mm ² | 8.0 | 12.0 | 1.9 | 4.4 | 1.1 | 1.000 | 0.370 |
| 3803 | JYF-0.50 | Beyaz | 0.50 mm ² | 8.0 | 14.0 | 2.6 | 6.0 | 1.3 | 1.000 | 0.180 |
| 3804 | JYF-0.75 | Mavi | 0.75 mm ² | 8.0 | 14.0 | 2.8 | 6.3 | 1.5 | 1.000 | 0.180 |
| 3805 | JYF-1.0 | Kırmızı | 1.00 mm ² | 8.0 | 14.0 | 3.0 | 6.3 | 1.7 | 1.000 | 0.180 |
| 3806 | JYF-1.5 | Siyah | 1.50 mm ² | 8.0 | 14.0 | 3.5 | 6.3 | 2.0 | 1.000 | 0.196 |
| 3807 | JYF-2.5 | Gri | 2.50 mm ² | 8.0 | 14.0 | 4.2 | 7.4 | 2.5 | 500 | 0.251 |
| 3808 | JYF-4.0 | Turuncu | 4.00 mm ² | 10.0 | 17.0 | 4.8 | 7.4 | 3.2 | 500 | 0.425 |
| 3809 | JYF-6.0 | Yeşil | 6.00 mm ² | 12.0 | 20.0 | 6.3 | 8.5 | 3.9 | 250 | 0.560 |
| 3810 | JYF-10.0 | Kahve | 10.0 mm ² | 12.0 | 20.0 | 6.3 | 8.5 | 3.9 | 100 | 0.710 |
| 3811 | JYF-16.0 | Bej | 16.0 mm ² | 12.0 | 24.0 | 8.8 | 10.0 | 6.2 | 100 | 1.000 |
| 3812 | JYF-25.0 | Siyah | 25.0 mm ² | 16.0 | 28.0 | 11.2 | 12.0 | 7.7 | 50 | 1.700 |
| 3813 | JYF-35.0 | Kırmızı | 35.0 mm ² | 16.0 | 30.0 | 12.7 | 14.0 | 8.7 | 50 | 2.120 |
| 3814 | JYF-50.0 | Mavi | 50.0 mm ² | 20.0 | 36.0 | 15.0 | 16.0 | 10.9 | 25 | 3.930 |
| 3815 | JYF-70.0 | Sarı | 70.0 mm ² | 21.0 | 37.0 | 16.0 | 17.0 | 14.3 | 25 | 7.400 |
| 3830 | JYF-95.0 | Kırmızı | 95.0 mm ² | 20.0 | 36.0 | 15.0 | 16.0 | 10.9 | 25 | 11.250 |

İZOLELİ KABLO YÜKSÜKLERİ ALMAN NORMU

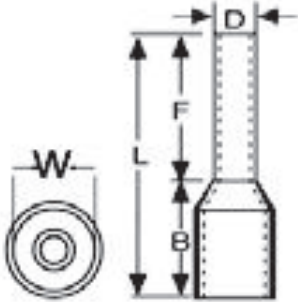

STANDART: DIN 46228

MALZEME: Bakır, Kalay Kaplı

İZOLASYON: Naylon

ÇALIŞMA SICAKLIĞI:
Maksimum 105 ° 600 volt Arası



| Sipariş Kodu | Ürün Kodu | Renk | Kablo Kesit (mm ²) | Ebatlar (mm) | | | | | Kutuj Adet | Birim Fiyat TL / Adet | |
|--------------|-----------------|------|--------------------------------|----------------------|------|------|------|------|------------|-----------------------|-------|
| | | | | F | L | W | B | D | | | |
| 3816 | JYA-0.25 | | Mavi | 0.25 mm ² | 8.0 | 12.0 | 1.6 | 2.8 | 0.9 | 1.000 | 0.370 |
| 3817 | JYA-0.34 | | Turkuaz | 0.34 mm ² | 8.0 | 12.0 | 1.9 | 4.4 | 1.1 | 1.000 | 0.370 |
| 3818 | JYA-0.50 | | Turuncu | 0.50 mm ² | 8.0 | 12.0 | 1.9 | 4.4 | 1.1 | 1.000 | 0.180 |
| 3819 | JYA-0.75 | | Beyaz | 0.75 mm ² | 8.0 | 14.0 | 2.6 | 6.0 | 1.3 | 1.000 | 0.180 |
| 3820 | JYA-1.0 | | Sarı | 1.00 mm ² | 8.0 | 14.0 | 2.8 | 6.3 | 1.5 | 1.000 | 0.180 |
| 3821 | JYA-1.5 | | Kırmızı | 1.50 mm ² | 8.0 | 14.0 | 3.0 | 6.3 | 1.7 | 1.000 | 0.196 |
| 3822 | JYA-2.5 | | Mavi | 2.50 mm ² | 8.0 | 14.0 | 3.5 | 6.3 | 2.0 | 500 | 0.251 |
| 3823 | JYA-4.0 | | Gri | 4.00 mm ² | 8.0 | 14.0 | 4.2 | 7.4 | 2.5 | 500 | 0.425 |
| 3824 | JYA-6.0 | | Siyah | 6.00 mm ² | 10.0 | 17.0 | 4.8 | 7.4 | 3.2 | 250 | 0.560 |
| 3825 | JYA-10.0 | | Bej | 10.0 mm ² | 12.0 | 20.0 | 6.3 | 8.5 | 3.9 | 100 | 0.710 |
| 3826 | JYA-16.0 | | Yeşil | 16.0 mm ² | 12.0 | 22.0 | 7.6 | 8.8 | 4.9 | 100 | 1.000 |
| 3827 | JYA-25.0 | | Kahve | 25.0 mm ² | 12.0 | 24.0 | 8.8 | 10.0 | 6.2 | 50 | 1.700 |
| 3828 | JYA-35.0 | | Bej | 35.0 mm ² | 16.0 | 28.0 | 11.2 | 12.0 | 7.7 | 50 | 2.120 |
| 3829 | JYA-50.0 | | Yeşil | 50.0 mm ² | 16.0 | 30.0 | 12.7 | 14.0 | 8.7 | 25 | 3.930 |

ÇİFT GİRİŞLİ KABLO YÜKSÜKLERİ FRANSIZ NORMU

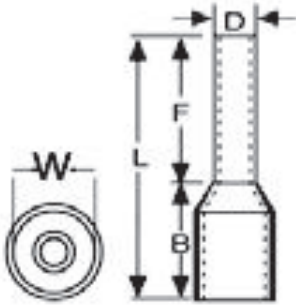
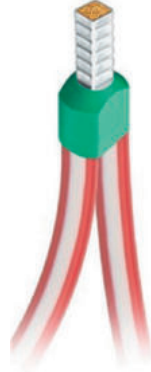

STANDART: DIN 46228

MALZEME: Bakır, Kalay Kaplı

İZOLASYON: Naylon

ÇALIŞMA SICAKLIĞI:
Maksimum 105 ° 600 volt Arası



| Sipariş Kodu | Ürün Kodu | Renk | Kablo Kesit (mm ²) | Ebatlar (mm) | | | | | Kutuj Adet | Birim Fiyat TL / Adet |
|--------------|-----------|---------|--------------------------------|--------------|------|------|------|-----|------------|-----------------------|
| | | | | F | L | W | B | D | | |
| 3831 | JCY-0.50F | Beyaz | 0.50 mm ² | 8.0 | 14.0 | 5.0 | 6.5 | 1.8 | 1.000 | 0.320 |
| 3832 | JCY-0.75F | Mavi | 0.75 mm ² | 8.0 | 14.0 | 5.5 | 6.7 | 2.1 | 500 | 0.334 |
| 3833 | JCY-1.0F | Kırmızı | 1.00 mm ² | 8.0 | 14.0 | 5.5 | 7.1 | 2.4 | 500 | 0.355 |
| 3834 | JCY-1.5F | Siyah | 1.50 mm ² | 8.0 | 14.0 | 6.4 | 7.5 | 2.6 | 500 | 0.430 |
| 3835 | JCY-2.5F | Gri | 2.50 mm ² | 10.0 | 14.0 | 8.0 | 8.5 | 3.3 | 250 | 0.700 |
| 3836 | JCY-4.0F | Turuncu | 4.00 mm ² | 12.0 | 17.0 | 8.0 | 11.1 | 4.2 | 200 | 0.805 |
| 3837 | JCY-6.0F | Yeşil | 6.00 mm ² | 14.0 | 20.0 | 9.5 | 12.1 | 5.3 | 100 | 0.996 |
| 3838 | JCY-10.0F | Kahve | 10.0 mm ² | 14.0 | 27.0 | 12.6 | 12.6 | 6.9 | 50 | 1.590 |
| 3839 | JCY-16.0F | Bej | 16.0 mm ² | 14.0 | 31.0 | 19.0 | 17.3 | 8.7 | 50 | 1.910 |

ÇİFT GİRİŞLİ KABLO YÜKSÜKLERİ ALMAN NORMU

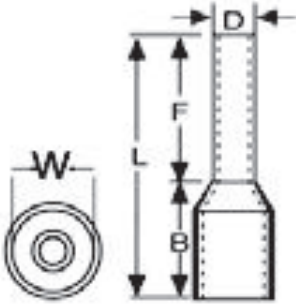

STANDART: DIN 46228

MALZEME: Bakır, Kalay Kaplı

İZOLASYON: Naylon

ÇALIŞMA SICAKLIĞI:
Maksimum 105 ° 600 volt Arası



| Sipariş Kodu | Ürün Kodu | Renk | Kablo Kesit (mm ²) | Ebatlar (mm) | | | | | Kutu Adet | Birim Fiyat TL / Adet | |
|--------------|------------------|------|--------------------------------|----------------------|------|------|------|------|-----------|-----------------------|-------|
| | | | | F | L | W | B | D | | | |
| 3840 | JCY-0.50A | | Turuncu | 0.50 mm ² | 8.0 | 14.0 | 5.0 | 6.5 | 1.8 | 1.000 | 0.320 |
| 3841 | JCY-0.75A | | Beyaz | 0.75 mm ² | 8.0 | 14.0 | 5.5 | 6.7 | 2.1 | 500 | 0.334 |
| 3842 | JCY-1.0A | | Sarı | 1.00 mm ² | 8.0 | 14.0 | 5.5 | 7.1 | 2.4 | 500 | 0.355 |
| 3843 | JCY-1.5A | | Kırmızı | 1.50 mm ² | 8.0 | 14.0 | 6.4 | 7.5 | 2.6 | 500 | 0.430 |
| 3844 | JCY-2.5A | | Mavi | 2.50 mm ² | 10.0 | 14.0 | 8.0 | 8.5 | 3.3 | 250 | 0.700 |
| 3845 | JCY-4.0A | | Gri | 4.00 mm ² | 12.0 | 17.0 | 8.0 | 11.1 | 4.2 | 200 | 0.805 |
| 3846 | JCY-6.0A | | Siyah | 6.00 mm ² | 14.0 | 20.0 | 9.5 | 12.1 | 5.3 | 100 | 0.996 |
| 3847 | JCY-10.0A | | Bej | 10.0 mm ² | 14.0 | 27.0 | 12.6 | 12.6 | 6.9 | 50 | 1.590 |
| 3848 | JCY-16.0A | | Yeşil | 16.0 mm ² | 14.0 | 31.0 | 19.0 | 17.3 | 8.7 | 50 | 1.910 |

İZOLESİZ KABLO YÜKSÜKLERİ



| Sipariş Kodu | Ürün Kodu | Kablo Kesit (mm ²) | Ebatlar (mm) | | | | Kutuj Adet | Birim Fiyat TL / Adet |
|--------------|-----------------|--------------------------------|--------------|------|------|------|------------|-----------------------|
| | | | L | W | D | C | | |
| 3849 | JKY-050 | 0.50 mm ² | 10 | 2.1 | 1.3 | 1.0 | 2.000 | 0.180 |
| 3850 | JKY-075 | 0.75 mm ² | 10 | 2.3 | 1.5 | 1.2 | 1.000 | 0.180 |
| 3851 | JKY-1.0 | 1.00 mm ² | 10 | 2.5 | 1.7 | 1.4 | 1.000 | 0.180 |
| 3852 | JKY-1.5 | 1.50 mm ² | 10 | 2.8 | 2.0 | 1.7 | 1.000 | 0.200 |
| 3853 | JKY-2.5 | 2.50 mm ² | 12 | 3.4 | 2.5 | 2.2 | 1.000 | 0.275 |
| 3854 | JKY-4.0 | 4.00 mm ² | 12 | 4.0 | 3.2 | 2.8 | 1.000 | 0.371 |
| 3855 | JKY-6.0 | 6.00 mm ² | 12 | 4.7 | 3.9 | 3.5 | 500 | 0.500 |
| 3856 | JKY-10.0 | 10.0 mm ² | 15 | 5.8 | 4.9 | 4.5 | 250 | 0.825 |
| 3857 | JKY-16.0 | 16.0 mm ² | 15 | 7.5 | 6.2 | 5.8 | 250 | 1.040 |
| 3858 | JKY-25.0 | 25.0 mm ² | 16 | 9.1 | 7.9 | 7.5 | 100 | 1.600 |
| 3859 | JKY-35.0 | 35.0 mm ² | 16 | 10.2 | 8.7 | 8.3 | 100 | 1.750 |
| 3860 | JKY-50.0 | 50.0 mm ² | 22 | 12.7 | 10.9 | 10.3 | 50 | 3.600 |
| 3861 | JKY-70.0 | 70.0 mm ² | 25.2 | 13.5 | 5.36 | 4.68 | 50 | 4.070 |
| 3862 | JKY-95.0 | 95.0 mm ² | 25.2 | 14.0 | 5.38 | 5.35 | 25 | 4.910 |



JAMESON®

KABLO UÇLARI VE TERMİNALLERİ

www.kivilcimelektrik.com.tr

YUVARLAK TİP İZOLELİ KABLO UÇLARI

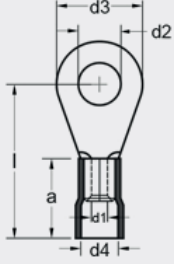

Standart : DIN 46237
 Malzeme : Bakır, Kalay Kaplı
 İzolasyon : PVC
 Çalışma Sıcaklığı : Maksimum 105° 600Volt Arası



| Sipariş Kodu | Ürün Kodu | Renk | Kablo Kesit (mm ²) | Civata Ölçüsü | Ebatlar (mm) | | | | | | Kutu Adet | Birim Fiyat TL / Adet |
|--------------|-----------|---------|--------------------------------|---------------|--------------|------|------|-----|-----|------|-----------|-----------------------|
| | | | | | d2 | d3 | l | d1 | d4 | a | | |
| 3901 | JYU-301 | Kırmızı | 0.50 - 1.50 mm ² | M3 | 3.2 | 6.0 | 16.0 | 1.6 | 4.0 | 10.0 | 200 | 0.572 |
| 3902 | JYU-401 | Kırmızı | | M4 | 4.3 | 8.0 | 17.0 | 1.6 | 4.0 | 10.0 | 200 | 0.850 |
| 3903 | JYU-501 | Kırmızı | | M5 | 5.3 | 10.0 | 18.0 | 1.6 | 4.0 | 10.0 | 200 | 0.860 |
| 3904 | JYU-601 | Kırmızı | | M6 | 6.5 | 10.0 | 18.0 | 1.6 | 4.0 | 10.0 | 200 | 1.345 |
| 3905 | JYU-801 | Kırmızı | | M8 | 8.4 | 14.0 | 22.0 | 1.6 | 4.0 | 10.0 | 200 | 1.380 |

| Sipariş Kodu | Ürün Kodu | Renk | Kablo Kesit (mm ²) | Civata Ölçüsü | Ebatlar (mm) | | | | | | Kutu Adet | Birim Fiyat TL / Adet |
|--------------|-----------|------|--------------------------------|---------------|--------------|------|------|-----|-----|------|-----------|-----------------------|
| | | | | | d2 | d3 | l | d1 | d4 | a | | |
| 3906 | JYU-302 | Mavi | 1.50 - 2.50 mm ² | M3 | 3.2 | 6.0 | 16.0 | 2.3 | 4.5 | 10.0 | 200 | 1.040 |
| 3907 | JYU-402 | Mavi | | M4 | 4.3 | 8.0 | 17.0 | 2.3 | 4.5 | 10.0 | 200 | 1.040 |
| 3908 | JYU-502 | Mavi | | M5 | 5.3 | 10.0 | 19.0 | 2.3 | 4.5 | 10.0 | 200 | 1.060 |
| 3910 | JYU-602 | Mavi | | M6 | 6.5 | 11.0 | 20.0 | 2.3 | 4.5 | 10.0 | 200 | 1.505 |
| 3911 | JYU-802 | Mavi | | M8 | 8.4 | 14.0 | 22.0 | 2.3 | 4.5 | 10.0 | 200 | 1.505 |
| 3912 | JYU-1002 | Mavi | | M10 | 10.5 | 15.0 | 22.0 | 2.3 | 4.5 | 10.0 | 200 | 1.537 |

| Sipariş Kodu | Ürün Kodu | Renk | Kablo Kesit (mm ²) | Civata Ölçüsü | Ebatlar (mm) | | | | | | Kutu Adet | Birim Fiyat TL / Adet |
|--------------|-----------|---------|--------------------------------|---------------|--------------|------|------|-----|-----|------|-----------|-----------------------|
| | | | | | d2 | d3 | l | d1 | d4 | a | | |
| 3913 | JYU-406 | Sarı | 4.00 - 6.00 mm ² | M4 | 4.3 | 8.6 | 21.0 | 3.6 | 6.3 | 13.0 | 100 | 2.195 |
| 3914 | JYU-506 | Sarı | | M5 | 5.3 | 10.0 | 22.0 | 3.6 | 6.3 | 13.0 | 100 | 2.195 |
| 3915 | JYU-606 | Sarı | | M6 | 6.5 | 11.0 | 22.5 | 3.6 | 6.3 | 13.0 | 100 | 2.470 |
| 3916 | JYU-806 | Sarı | | M8 | 8.4 | 14.0 | 26.0 | 3.6 | 6.3 | 13.0 | 100 | 3.130 |
| 3917 | JYU-1006 | Sarı | | M10 | 10.5 | 18.0 | 28.0 | 3.6 | 6.3 | 13.0 | 100 | 3.180 |
| 3918 | JYU-1206 | Sarı | | M12 | 13.0 | 18.0 | 28.0 | 3.6 | 6.3 | 13.0 | 100 | 3.235 |
| 3919 | JYU-610 | Kırmızı | 8.00 - 10.00 mm ² | M6 | 6.7 | 23.5 | 30.0 | 4.5 | 8.0 | 17.0 | 50 | 4.240 |
| 3920 | JYU-810 | Kırmızı | | M8 | 8.4 | 26.3 | 36.0 | 4.5 | 8.0 | 17.0 | 50 | 4.665 |

ÇATAL TIP İZOLELİ KABLO UÇLARI

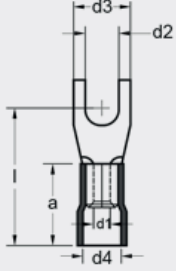

Standart : DIN 46237
 Malzeme : Bakır, Kalay Kaplı
 İzolasyon : PVC
 Çalışma Sıcaklığı : Maksimum 105° 600Volt Arası



| Sipariş Kodu | Ürün Kodu | Renk | Kablo Kesit (mm ²) | Civata Ölçüsü | Ebatlar (mm) | | | | | | Kutu Adet | Birim Fiyat TL / Adet |
|--------------|-----------|---------|--------------------------------|---------------|--------------|------|------|-----|-----|------|-----------|-----------------------|
| | | | | | d2 | d3 | l | d1 | d4 | a | | |
| 3921 | JÇU-3001 | Kırmızı | 0.50 - 1.50 mm ² | M3 | 3.2 | 6.0 | 16.0 | 1.6 | 4.0 | 10.0 | 200 | 0.758 |
| 3922 | JÇU-4001 | Kırmızı | | M4 | 4.3 | 8.0 | 17.0 | 1.6 | 4.0 | 10.0 | 200 | 0.800 |
| 3923 | JÇU-5001 | Kırmızı | | M5 | 5.3 | 10.0 | 18.0 | 1.6 | 4.0 | 10.0 | 200 | 0.805 |
| 3924 | JÇU-6001 | Kırmızı | | M6 | 6.5 | 11.0 | 20.0 | 1.6 | 4.0 | 10.0 | 200 | 0.912 |

| Sipariş Kodu | Ürün Kodu | Renk | Kablo Kesit (mm ²) | Civata Ölçüsü | Ebatlar (mm) | | | | | | Kutu Adet | Birim Fiyat TL / Adet |
|--------------|-----------|------|--------------------------------|---------------|--------------|------|------|-----|-----|------|-----------|-----------------------|
| | | | | | d2 | d3 | l | d1 | d4 | a | | |
| 3925 | JÇU-3002 | Mavi | 0.50 - 1.50 mm ² | M3 | 3.2 | 5.5 | 18.0 | 2.3 | 4.5 | 10.0 | 200 | 0.838 |
| 3926 | JÇU-4002 | Mavi | | M4 | 4.3 | 6.8 | 17.0 | 2.3 | 4.5 | 10.0 | 200 | 0.860 |
| 3927 | JÇU-5002 | Mavi | | M5 | 5.3 | 10.0 | 19.0 | 2.3 | 4.5 | 10.0 | 200 | 0.870 |
| 3928 | JÇU-6002 | Mavi | | M6 | 6.5 | 11.0 | 21.0 | 2.3 | 4.5 | 10.0 | 200 | 1.165 |

| Sipariş Kodu | Ürün Kodu | Renk | Kablo Kesit (mm ²) | Civata Ölçüsü | Ebatlar (mm) | | | | | | Kutu Adet | Birim Fiyat TL / Adet |
|--------------|-----------|------|--------------------------------|---------------|--------------|------|------|-----|------|------|-----------|-----------------------|
| | | | | | d2 | d3 | l | d1 | d4 | a | | |
| 3929 | JÇU-4006 | Sarı | 4.00 - 6.00 mm ² | M4 | 4.3 | 8.0 | 21.0 | 3.6 | 13.0 | 10.0 | 100 | 1.920 |
| 3930 | JÇU-5006 | Sarı | | M5 | 5.3 | 10.0 | 22.0 | 3.6 | 6.3 | 13.0 | 100 | 1.930 |
| 3931 | JÇU-6006 | Sarı | | M6 | 6.5 | 11.0 | 23.0 | 3.6 | 6.3 | 13.0 | 100 | 2.620 |
| 3932 | JÇU-8006 | Sarı | | M8 | 8.4 | 14.0 | 26.0 | 3.6 | 6.3 | 13.0 | 100 | 2.970 |

EK MUFLARI İZOLELİ KABLO UÇLARI

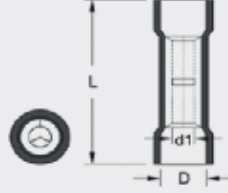

STANDART: DIN 46237
MALZEME: Bakır, Kalay Kaplı
İZOLASYON: PVC
ÇALIŞMA SICAKLIĞI: Maksimum 75° 600 Volt Arası

| Sipariş Kodu | Ürün Kodu | Renk | Kablo Kesit (mm ²) | Ebatlar (mm) | | | Kutu Adet | Birim Fiyat TL / Adet |
|--------------|----------------|-----------|--------------------------------|--------------|-----|-----|-----------|-----------------------|
| | | | | L | D | d1 | | |
| 3933 | JBY-251 | ■ Kırmızı | 0.50 - 1.50 mm ² | 24.6 | 4.0 | 1.7 | 200 | 1.165 |
| 3934 | JBY-252 | ■ Mavi | 1.50 - 2.50 mm ² | 24.6 | 4.5 | 2.3 | 200 | 1.220 |
| 3935 | JBY-256 | ■ Sarı | 4.00 - 6.00 mm ² | 26.5 | 6.3 | 3.4 | 100 | 2.015 |

ERKEK TERMİNALLER İZOLELİ KABLO UÇLARI



MALZEME: Piring, Kalay Kaplı, Bakır Yüksüklü
İZOLASYON: PVC
ÇALIŞMA SICAKLIĞI: Maksimum 75° 600 Volt Arası

| Sipariş Kodu | Ürün Kodu | Renk | Kablo Kesit (mm ²) | Ebatlar (mm) | | | | | Kutu Adet | Birim Fiyat TL / Adet |
|--------------|-----------------|-----------|--------------------------------|--------------|-----|------|------|-----|-----------|-----------------------|
| | | | | W | F | L | B | D | | |
| 3936 | JBE-1041 | ■ Kırmızı | 0.50 - 1.50 mm ² | 4.0 | 8.5 | 21.5 | 10.5 | 3.8 | 200 | 2.015 |
| 3937 | JBE-2052 | ■ Mavi | 1.50 - 2.50 mm ² | 5.0 | 8.5 | 21.2 | 10.5 | 4.7 | 200 | 2.225 |
| 3938 | JBE-5056 | ■ Sarı | 4.00 - 6.00 mm ² | 5.0 | 8.5 | 24.0 | 13.0 | 6.2 | 200 | 3.020 |

DIŞI TERMİNALLER İZOLELİ KABLO UÇLARI

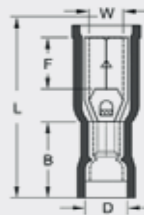

MALZEME: Piring, Kalay Kaplı, Bakır Yüksüklü
İZOLASYON: PVC
ÇALIŞMA SICAKLIĞI: Maksimum 75° 600 Volt Arası

| Sipariş Kodu | Ürün Kodu | Renk | Kablo Kesit (mm ²) | Ebatlar (mm) | | | | | Kutu Adet | Birim Fiyat TL / Adet |
|--------------|-----------------|-----------|--------------------------------|--------------|-----|------|------|-----|-----------|-----------------------|
| | | | | W | F | L | B | D | | |
| 3939 | JBD-1041 | ■ Kırmızı | 0.50 - 1.50 mm ² | 3.9 | 7.0 | 23.3 | 10.5 | 3.8 | 200 | 2.385 |
| 3940 | JBD-2052 | ■ Mavi | 1.50 - 2.50 mm ² | 4.9 | 7.0 | 23.3 | 10.5 | 4.7 | 100 | 2.650 |
| 3941 | JBD-5056 | ■ Sarı | 4.00 - 6.00 mm ² | 4.9 | 7.0 | 25.1 | 12.5 | 6.2 | 100 | 3.285 |

DIŐI FASTON TİP İZOLELİ KABLO UÇLARI

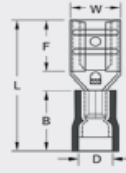

MALZEME: Piriç, Kalay Kaplı
İZOLASYON: PVC
ÇALIŐMA SICAKLIĐI: Maksimum 75° 600 Volt Arası

| SipariŐ Kodu | Ürün Kodu | Renk | Kablo Kesit (mm ²) | Soket GeniŐliĐi | Ebatlar (mm) | | | | | Kutu Adet | Birim Fiyat TL / Adet |
|--------------|-----------|---------|--------------------------------|-----------------|--------------|-----|------|------|-----|-----------|-----------------------|
| | | | | | W | F | L | B | D | | |
| 3942 | JFD-1288 | Kırmızı | 0.50 - 1.50 mm ² | 0.8 x 2.80 | 3.2 | 6.5 | 19.0 | 10.5 | 3.8 | 200 | 0.583 |
| 3943 | JFD-1488 | Kırmızı | | 0.8 x 4.75 | 5.0 | 6.4 | 19.4 | 10.5 | 3.8 | 200 | 0.700 |
| 3944 | JFD-1638 | Kırmızı | | 0.8 x 6.35 | 6.6 | 7.5 | 20.8 | 10.5 | 3.8 | 200 | 0.900 |
| 3945 | JFD-2288 | Mavi | 1.50 - 2.50 mm ² | 0.8 x 2.80 | 3.2 | 6.5 | 19.0 | 10.5 | 3.8 | 200 | 0.700 |
| 3946 | JFD-2488 | Mavi | | 0.8 x 4.75 | 5.0 | 6.4 | 19.4 | 10.5 | 3.8 | 200 | 0.795 |
| 3947 | JFD-2638 | Mavi | | 0.8 x 6.35 | 6.6 | 7.5 | 20.8 | 10.5 | 3.8 | 200 | 0.900 |
| 3948 | JFD-5638 | Sarı | 4.00 - 6.00 mm ² | 0.8 x 6.35 | 6.6 | 7.5 | 23.3 | 13.0 | 6.2 | 200 | 1.115 |

TAM İZOLELİ DIŐI FASTON TİP KABLO UÇLARI

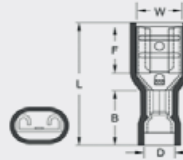

MALZEME: Piriç, Kalay Kaplı
İZOLASYON: PVC
ÇALIŐMA SICAKLIĐI: Maksimum 75° 600 Volt Arası

| SipariŐ Kodu | Ürün Kodu | Renk | Kablo Kesit (mm ²) | Soket GeniŐliĐi | Ebatlar (mm) | | | | | Kutu Adet | Birim Fiyat TL / Adet |
|--------------|-----------|---------|--------------------------------|-----------------|--------------|-----|------|------|-----|-----------|-----------------------|
| | | | | | W | F | L | B | D | | |
| 3949 | JFFD-1288 | Kırmızı | 0.50 - 1.50 mm ² | 0.8 x 2.80 | 3.2 | 6.5 | 19.0 | 10.5 | 3.8 | 200 | 0.830 |
| 3950 | JFFD-1488 | Kırmızı | | 0.8 x 4.75 | 5.0 | 6.4 | 20.8 | 10.5 | 3.8 | 200 | 0.925 |
| 3951 | JFFD-1638 | Kırmızı | | 0.8 x 6.35 | 6.6 | 7.5 | 21.8 | 10.5 | 3.8 | 200 | 1.220 |
| 3952 | JFFD-2288 | Mavi | 1.50 - 2.50 mm ² | 0.8 x 2.80 | 3.2 | 6.5 | 20.0 | 10.5 | 4.7 | 200 | 0.925 |
| 3953 | JFFD-2488 | Mavi | | 0.8 x 4.75 | 5.0 | 6.4 | 20.2 | 10.5 | 4.7 | 200 | 0.935 |
| 3954 | JFFD-2638 | Mavi | | 0.8 x 6.35 | 6.6 | 7.5 | 22.2 | 10.5 | 4.7 | 200 | 1.225 |
| 3955 | JFFD-5638 | Sarı | 4.00 - 6.00 mm ² | 0.8 x 6.35 | 6.6 | 7.5 | 24.2 | 12.5 | 6.2 | 100 | 1.335 |

TAM İZOLELİ POLYAMİD DIŐI FASTON TİP KABLO UÇLARI

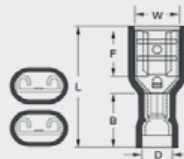

MALZEME: Piriç, Kalay Kaplı
İZOLASYON: Polyamid
ÇALIŐMA SICAKLIĐI: Maksimum 75° 600 Volt Arası

| SipariŐ Kodu | Ürün Kodu | Renk | Kablo Kesit (mm ²) | Soket GeniŐliĐi | Ebatlar (mm) | | | | | Kutu Adet | Birim Fiyat TL / Adet |
|--------------|-----------|---------|--------------------------------|-----------------|--------------|-----|------|------|-----|-----------|-----------------------|
| | | | | | W | F | L | B | D | | |
| 3956 | JPFD-1638 | Kırmızı | 0.50 - 1.50 mm ² | 0.8 x 6.35 | 6.6 | 7.5 | 21.5 | 11.0 | 4.0 | 200 | 2.760 |
| 3957 | JPFD-2638 | Mavi | 1.50 - 2.50 mm ² | 0.8 x 6.35 | 6.6 | 7.5 | 21.5 | 11.0 | 5.0 | 200 | 2.760 |
| 3958 | JPFD-5638 | Sarı | 4.00 - 6.00 mm ² | 0.8 x 6.35 | 6.6 | 7.5 | 24.2 | 13.0 | 6.5 | 100 | 3.300 |

İĞNE TİP İZOLELİ KABLO UÇLARI

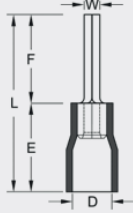

MALZEME: Bakır, Kalay Kaplı
İZOLASYON: PVC
ÇALIŞMA SICAKLIĞI: Maksimum 75° 600 Volt Arası



| Sipariş Kodu | Ürün Kodu | Renk | Kablo Kesit (mm ²) | Ebatlar (mm) | | | | | Kutu Adet | Birim Fiyat TL / Adet |
|--------------|----------------|-----------|--------------------------------|--------------|------|------|------|-----|-----------|-----------------------|
| | | | | W | F | L | B | D | | |
| 3959 | JIK-101 | ■ Kırmızı | 0.50 - 1.50 mm ² | 1.9 | 10.0 | 19.0 | 10.0 | 4.0 | 200 | 0.880 |
| 3960 | JIK-102 | ■ Mavi | 1.50 - 2.50 mm ² | 1.9 | 12.0 | 21.8 | 10.0 | 4.5 | 200 | 1.065 |
| 3961 | JIK-106 | ■ Sarı | 4.00 - 6.00 mm ² | 2.8 | 14.0 | 27.0 | 27.0 | 6.4 | 100 | 2.545 |

ERKEK / DIŞI GERİ DÖNÜŞLÜ TERMİNALLER

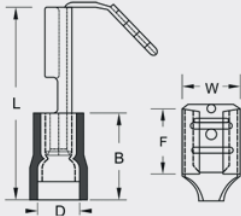

MALZEME: Piriç, Kalay Kaplı
İZOLASYON: PVC
ÇALIŞMA SICAKLIĞI: Maksimum 75° 600 Volt Arası



| Sipariş Kodu | Ürün Kodu | Renk | Kablo Kesit (mm ²) | Soket Genişliği | Ebatlar (mm) | | | | | Kutu Adet | Birim Fiyat TL / Adet |
|--------------|-------------------|-----------|--------------------------------|-----------------|--------------|-----|------|------|-----|-----------|-----------------------|
| | | | | | W | F | L | B | D | | |
| 3962 | JFDEG-1861 | ■ Kırmızı | 0.50 - 1.50 mm ² | 0.8 x 2.80 | 6.6 | 8.0 | 22.5 | 10.5 | 3.8 | 100 | 1.595 |
| 3963 | JFDEG-2862 | ■ Mavi | 1.50 - 2.50 mm ² | 0.8 x 4.75 | 6.6 | 8.0 | 22.5 | 10.5 | 4.7 | 100 | 1.595 |
| 3964 | JFDEG-5866 | ■ Sarı | 4.00 - 6.00 mm ² | 0.8 x 6.35 | 6.6 | 8.0 | 24.0 | 13.0 | 6.2 | 100 | 1.800 |

TAM İZOLELİ POLYAMİD BAYRAK TİP TERMİNALLER

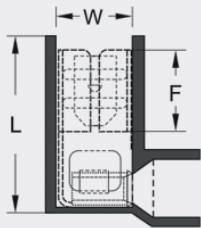

MALZEME: Piriç, Kalay Kaplı
İZOLASYON: Polyamid
ÇALIŞMA SICAKLIĞI: Maksimum 75° 600 Volt Arası



| Sipariş Kodu | Ürün Kodu | Renk | Kablo Kesit (mm ²) | Ebatlar (mm) | | | Kutu Adet | Birim Fiyat TL / Adet |
|--------------|--------------------|-----------|--------------------------------|--------------|-----|------|-----------|-----------------------|
| | | | | W | F | L | | |
| 3965 | JPFDEB-1861 | ■ Kırmızı | 0.8 x 6.35 | 6.6 | 7.6 | 16.0 | 100 | 2.020 |
| 3966 | JPFDEB-2862 | ■ Mavi | 0.8 x 6.35 | 6.6 | 7.6 | 16.0 | 100 | 2.020 |

ERKEK FASTON TİP KABLO UÇLARI

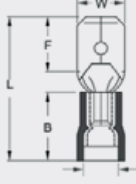

MALZEME: Piring, Kalay Kaplı
İZOLASYON: PVC
ÇALIŞMA SICAKLIĞI: Maksimum 75° 600 Volt Arası



| Sipariş Kodu | Ürün Kodu | Renk | Kablo Kesit (mm ²) | Soket Genişliği | Ebatlar (mm) | | | | | Kutu Adet | Birim Fiyat TL / Adet |
|--------------|-----------|---------|--------------------------------|-----------------|--------------|------|------|------|-----|-----------|-----------------------|
| | | | | | W | F | L | B | D | | |
| 3967 | JFE-1288 | Kırmızı | 0.50 - 1.50 mm ² | 0.8 x 2.80 | 2.8 | 6.5 | 19.2 | 10.5 | 3.8 | 200 | 0.640 |
| 3968 | JFE-1488 | Kırmızı | | 0.8 x 4.75 | 4.8 | 6.7 | 19.8 | 10.5 | 3.8 | 200 | 0.640 |
| 3969 | JFE-1638 | Kırmızı | | 0.8 x 6.35 | 6.35 | 6.35 | 21.8 | 10.5 | 3.8 | 200 | 0.755 |
| 3970 | JFE-2288 | Mavi | 1.50 - 2.50 mm ² | 0.8 x 2.80 | 2.8 | 6.7 | 19.8 | 10.5 | 4.7 | 200 | 0.640 |
| 3971 | JFE-2488 | Mavi | | 0.8 x 4.75 | 4.8 | 6.7 | 19.8 | 10.5 | 4.7 | 200 | 0.640 |
| 3972 | JFE-2638 | Mavi | | 0.8 x 6.35 | 6.35 | 7.7 | 21.8 | 10.5 | 4.7 | 200 | 0.830 |
| 3973 | JFE-5638 | Sarı | 4.00 - 6.00 mm ² | 0.8 x 6.35 | 6.35 | 7.7 | 24.8 | 13.0 | 6.2 | 200 | 0.985 |

VİDALI BUAT KLEMENSLERİ

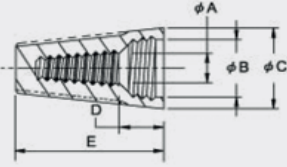

MALZEME: Piring, Kalay Kaplı
İZOLASYON: PVC
ÇALIŞMA SICAKLIĞI: Maksimum 75° 600 Volt Arası



| Sipariş Kodu | Ürün Kodu | Renk | Ebatlar (mm) | | | | | Kutu Adet | Birim Fiyat TL / Adet |
|--------------|-----------|---------|--------------|-------|-------|------|-------|-----------|-----------------------|
| | | | A | B | C | D | E | | |
| 3974 | J-1 | Gri | 3.8 | 6.70 | 8.60 | 5.80 | 15.20 | 1.000 | 0.485 |
| 3975 | J-2 | Mavi | 4.10 | 7.00 | 9.80 | 5.90 | 17.60 | 1.000 | 0.565 |
| 3976 | J-3 | Turuncu | 5.00 | 9.90 | 12.20 | 7.80 | 22.00 | 500 | 0.785 |
| 3977 | J-4 | Sarı | 6.00 | 11.20 | 14.00 | 7.90 | 24.00 | 500 | 1.310 |
| 3978 | J-6 | Kırmızı | 7.50 | 13.00 | 16.40 | 9.15 | 26.50 | 500 | 1.825 |

HIZLI KABLO EKLEME PARÇASI

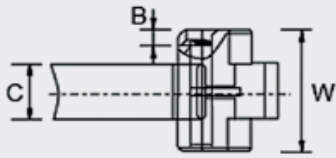

MALZEME: Piring, Kalay Kaplı
İZOLASYON: Naylon
ÇALIŞMA SICAKLIĞI: Maksimum 75° 600 Volt Arası

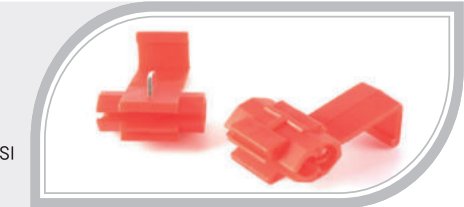

| Sipariş Kodu | Ürün Kodu | Renk | Kablo Kesit (mm ²) | Ebatlar (mm) | | | Kutu Adet | Birim Fiyat TL / Adet |
|--------------|-----------|---------|--------------------------------|--------------|------|------|-----------|-----------------------|
| | | | | W | F | L | | |
| 3979 | JP-1 | Kırmızı | 0.50 - 1.00 | 4.0 | 10.6 | 20.0 | 500 | 1.170 |
| 3980 | JP-2 | Mavi | 1.50 - 2.50 | 4.0 | 10.6 | 20.0 | 500 | 1.170 |
| 3981 | JP-5 | Sarı | 4.00 - 6.00 | 4.0 | 2.0 | 20.0 | 250 | 1.900 |

İZOLESİZ KABLO UCU VE KONNEKTÖRLERİ

| | | | | | |
|----------------------|-------------------------------|-----------------------------------|--------------------------|-------------------------------|-------------------------------|
| | | | | | |
| SİPARİŞ KODU | 4001 | 4002 | 4003 | 4004 | 4005 |
| ÜRÜN KODU | JF1/2D | JF1D MİNİ | JF1D | JF3D | JF2D TRK |
| AÇIKLAMA | 2.8 Mikro Dişi Terminal | 4.8 Mini Dişi Terminal | 6.3 Dişi Terminal | 9.5 Dişi Terminal | 6.3 Tırnaklı Dişi Terminal |
| KUTU ADET | 1.000 | 500 | 300 | 100 | 300 |
| BİRİM FİYATI TL./Ad. | 0.455 | 0.555 | 0.720 | 2.070 | 0.720 |
| | | | | | |
| SİPARİŞ KODU | 4006 | 4007 | 4008 | 4009 | 4010 |
| ÜRÜN KODU | JF1D EĞRİ | JF1D E | JKN 1-03 | JKN 1-04 | JKN 2.5-04 |
| AÇIKLAMA | 6.3 Eğri Dişi Terminal | 6.3 Erkek Geri Dönüşümlü Terminal | M3 Topraklama Terminali | M4 Topraklama Terminali | M4 Topraklama Terminali |
| KUTU ADET | 250 | 200 | 500 | 500 | 500 |
| BİRİM FİYATI TL./Ad. | 0.935 | 1.805 | 0.670 | 0.670 | 0.710 |
| | | | | | |
| SİPARİŞ KODU | 4011 | 4012 | 4013 | 4014 | 4015 |
| ÜRÜN KODU | JKN 2.5-05 | JKN 2.5-06 | JKN 4-04 | JKN 4-05 | JKN 4-06 |
| AÇIKLAMA | M5 Topraklama Terminali | M6 Topraklama Terminali | M4 Topraklama Terminali | M5 Topraklama Terminali | M6 Topraklama Terminali |
| KUTU ADET | 500 | 500 | 250 | 250 | 250 |
| BİRİM FİYATI TL./Ad. | 0.720 | 0.720 | 1.340 | 1.340 | 1.340 |
| | | | | | |
| SİPARİŞ KODU | 4016 | 4017 | 4018 | 4019 | 4020 |
| ÜRÜN KODU | JKN 6-06 | JKN 8-08 | JKN 10-10 | JK 2.5 | JK 4 |
| AÇIKLAMA | M6 Topraklama Terminali | M8 Topraklama Terminali | M10 Topraklama Terminali | Boru Tip Topraklama Terminali | Boru Tip Topraklama Terminali |
| KUTU ADET | 150 | 150 | 100 | 1.000 | 500 |
| BİRİM FİYATI TL./Ad. | 2.075 | 2.075 | 2.400 | 0.720 | 1.175 |
| | | | | | |
| SİPARİŞ KODU | 4021 | 4022 | 4023 | 4024 | 4025 |
| ÜRÜN KODU | JK 6 | JF1E ÇK | JF1EU1 | R TİPİ KONNEKTÖR | JF1D KILIF |
| AÇIKLAMA | Boru Tip Topraklama Terminali | 6.3 Erkek Terminal | 6.3 Uzun Erkek Terminal | 6.3 Kilitli Konnektör | 6.3 Terminal Kılıfı |
| KUTU ADET | 250 | 300 | 300 | 300 | 300 |
| BİRİM FİYATI TL./Ad. | 1.720 | 0.755 | 0.940 | 0.610 | 0.455 |

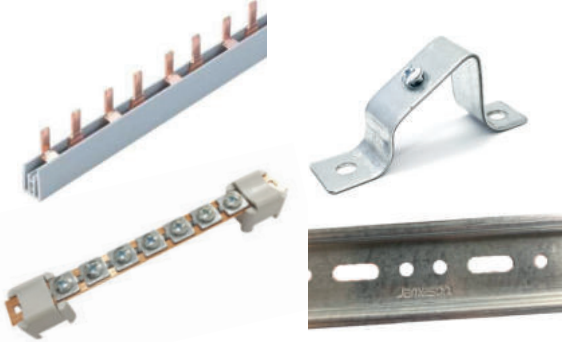

JAMESON®

BAĞLANTI ELEMENLARI

www.kivilcimelektrik.com.tr

SKP-E EKONOMİK TİP KABLO PABUCU

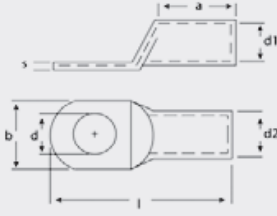

MALZEME: EN13600 Standart Bakır
Yüzey: Kalay



| Sipariş Kodu | Ürün Kodu | Kablo Kesit (mm ²) | Delik Çapı ø | Ebatlar (mm) | | | | | | Kutu Adet | Birim Fiyat TL / Adet |
|--------------|---------------------|--------------------------------|--------------|--------------|------|------|------|------|------|-----------|-----------------------|
| | | | | d | d1 | d2 | l | a | b | | |
| 4101 | SKP-E 16-6 | 16 mm ² | M6 | 6.5 | 5.5 | 7.0 | 32.5 | 11.0 | 10.0 | 500 | 4.85 |
| 4102 | SKP-E 16-8 | | M8 | 8.5 | 5.5 | 7.0 | 32.5 | 11.0 | 10.0 | 500 | 4.85 |
| 4103 | SKP-E 25-6 | 25 mm ² | M6 | 6.5 | 7.0 | 9.0 | 38.5 | 16.0 | 13.0 | 400 | 9.20 |
| 4104 | SKP-E 25-8 | | M8 | 8.5 | 7.0 | 9.0 | 38.5 | 16.0 | 13.0 | 400 | 9.20 |
| 4105 | SKP-E 35-6 | 35 mm ² | M6 | 6.5 | 8.5 | 10.5 | 43.5 | 19.0 | 15.5 | 300 | 12.50 |
| 4106 | SKP-E 35-8 | | M8 | 8.3 | 8.5 | 10.5 | 43.5 | 19.0 | 15.5 | 300 | 12.50 |
| 4107 | SKP-E 50-8 | 50 mm ² | M8 | 8.5 | 10.0 | 12.0 | 51.5 | 21.0 | 17.6 | 200 | 17.00 |
| 4108 | SKP-E 50-10 | | M10 | 10.5 | 10.0 | 12.0 | 51.5 | 21.0 | 17.6 | 200 | 17.00 |
| 4109 | SKP-E 70-10 | 70 mm ² | M10 | 10.5 | 11.5 | 14.0 | 55.5 | 23.0 | 20.7 | 100 | 25.00 |
| 4110 | SKP-E 70-12 | | M12 | 13.0 | 11.5 | 14.0 | 55.5 | 23.0 | 20.7 | 100 | 25.00 |
| 4111 | SKP-E 95-10 | 95 mm ² | M10 | 10.5 | 13.5 | 16.0 | 58.5 | 26.0 | 23.5 | 75 | 31.00 |
| 4112 | SKP-E 95-12 | | M12 | 13.0 | 13.5 | 16.0 | 58.5 | 26.0 | 23.5 | 75 | 31.00 |
| 4113 | SKP-E 120-10 | 120 mm ² | M10 | 10.5 | 15.5 | 18.0 | 71.0 | 29.0 | 26.7 | 50 | 45.00 |
| 4114 | SKP-E 120-12 | | M12 | 13.0 | 15.5 | 18.0 | 71.0 | 29.0 | 26.7 | 50 | 45.00 |
| 4115 | SKP-E 150-10 | 150 mm ² | M10 | 10.5 | 16.5 | 20.0 | 76.0 | 30.0 | 29.2 | 40 | 67.00 |
| 4116 | SKP-E 150-12 | | M12 | 13.0 | 16.5 | 20.0 | 76.5 | 30.0 | 29.2 | 40 | 67.00 |
| 4117 | SKP-E 185-12 | 185 mm ² | M12 | 13.0 | 18.5 | 22.0 | 82.0 | 33.0 | 32.3 | 30 | 85.00 |
| 4118 | SKP-E 185-16 | | M16 | 17.0 | 18.5 | 22.0 | 82.0 | 33.0 | 32.3 | 30 | 85.00 |
| 4119 | SKP-E 240-12 | 240 mm ² | M12 | 13.0 | 21.5 | 25.5 | 91.0 | 38.0 | 37.6 | 25 | 125.00 |
| 4120 | SKP-E 240-16 | | M16 | 17.0 | 21.5 | 25.5 | 91.0 | 38.0 | 37.6 | 25 | 125.00 |

SKP-S STANDART TİP KABLO PABUCU

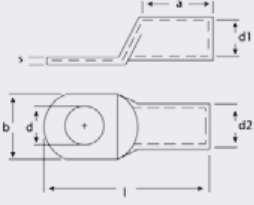

MALZEME: EN13600 Standart Bakır
Yüzey: Kalay



| Sipariş Kodu | Ürün Kodu | Kablo Kesit (mm ²) | Delik Çapı ø | Ebatlar (mm) | | | | | | | | Kutu Adet | Birim Fiyat TL / Adet | |
|--------------|--------------|--------------------------------|--------------|--------------|------|------|------|------|------|------|------|-----------|-----------------------|--------|
| | | | | d | d1 | d2 | l | l1 | a | b | c1 | | | c2 |
| 4121 | SKP-S 10-5 | 10 mm ² | M5 | 5.5 | 4.4 | 6.0 | 27.5 | 21.6 | 10.0 | 10.3 | 6.0 | 6.0 | 1000 | 4.60 |
| 4122 | SKP-S 10-6 | | M6 | 6.5 | 4.4 | 6.0 | 27.5 | 21.6 | 10.0 | 10.3 | 6.0 | 6.0 | 1000 | 4.60 |
| 4123 | SKP-S 10-8 | | M8 | 8.5 | 4.4 | 6.0 | 27.5 | 21.6 | 10.0 | 13.5 | 6.0 | 6.0 | 1000 | 4.60 |
| 4124 | SKP-S 16-6 | 16 mm ² | M6 | 6.5 | 5.5 | 8.0 | 32.6 | 25.0 | 12.0 | 11.2 | 7.0 | 8.0 | 500 | 6.50 |
| 4125 | SKP-S 16-8 | | M8 | 8.5 | 5.5 | 8.0 | 32.6 | 25.0 | 12.0 | 13.7 | 7.0 | 8.0 | 500 | 7.20 |
| 4126 | SKP-S 16-10 | | M10 | 10.5 | 5.5 | 8.0 | 32.6 | 25.0 | 12.0 | 16.0 | 7.0 | 8.0 | 500 | 7.20 |
| 4127 | SKP-S 25-6 | 25 mm ² | M6 | 6.5 | 6.8 | 9.0 | 39.0 | 32.2 | 16.0 | 13.5 | 6.8 | 9.2 | 400 | 12.00 |
| 4128 | SKP-S 25-8 | | M8 | 8.5 | 6.8 | 9.0 | 39.0 | 32.2 | 16.0 | 13.5 | 6.8 | 9.2 | 400 | 12.00 |
| 4129 | SKP-S 25-10 | | M10 | 10.5 | 7.0 | 9.5 | 42.0 | 34.0 | 16.0 | 16.0 | 6.8 | 11.0 | 400 | 12.50 |
| 4130 | SKP-S 35-6 | 35 mm ² | M6 | 6.5 | 8.2 | 11.0 | 44.0 | 35.7 | 19.0 | 15.7 | 8.0 | 9.7 | 200 | 16.00 |
| 4131 | SKP-S 35-8 | | M8 | 8.5 | 8.2 | 11.0 | 44.0 | 35.7 | 19.0 | 15.7 | 8.0 | 9.7 | 200 | 16.00 |
| 4132 | SKP-S 35-10 | | M10 | 10.5 | 8.2 | 11.0 | 48.0 | 38.0 | 19.0 | 15.7 | 10.0 | 12.0 | 200 | 17.50 |
| 4133 | SKP-S 50-8 | 50 mm ² | M8 | 8.5 | 9.5 | 12.0 | 47.5 | 39.2 | 21.0 | 17.7 | 8.3 | 9.7 | 150 | 23.00 |
| 4134 | SKP-S 50-10 | | M10 | 10.5 | 9.5 | 12.0 | 51.5 | 41.5 | 21.0 | 17.7 | 10.0 | 12.0 | 150 | 24.50 |
| 4135 | SKP-S 50-12 | | M12 | 13.0 | 10.1 | 13.0 | 51.5 | 41.5 | 21.0 | 19.0 | 10.0 | 12.0 | 150 | 24.50 |
| 4136 | SKP-S 50-14 | | M14 | 15.0 | 10.1 | 13.0 | 56.5 | 44.5 | 21.0 | 20.5 | 12.0 | 15.0 | 150 | 24.50 |
| 4137 | SKP-S 70-8 | 70 mm ² | M8 | 8.5 | 11.2 | 14.5 | 54.6 | 44.6 | 23.0 | 21.1 | 10.0 | 12.0 | 100 | 34.00 |
| 4138 | SKP-S 70-10 | | M10 | 10.5 | 11.2 | 14.5 | 54.6 | 44.6 | 23.0 | 21.1 | 10.0 | 12.0 | 100 | 34.00 |
| 4139 | SKP-S 70-12 | | M12 | 13.0 | 11.2 | 14.5 | 54.6 | 44.6 | 23.0 | 21.1 | 10.0 | 12.0 | 100 | 34.00 |
| 4140 | SKP-S 70-14 | | M14 | 15.0 | 11.2 | 14.5 | 62.6 | 47.6 | 23.0 | 21.4 | 15.0 | 15.0 | 100 | 39.00 |
| 4141 | SKP-S 95-8 | 95 mm ² | M8 | 8.5 | 13.4 | 17.0 | 58.8 | 48.8 | 26.0 | 24.5 | 10.0 | 12.0 | 75 | 43.00 |
| 4142 | SKP-S 95-10 | | M10 | 10.5 | 13.4 | 17.0 | 58.8 | 48.8 | 26.0 | 24.5 | 10.0 | 12.0 | 75 | 43.00 |
| 4143 | SKP-S 95-12 | | M12 | 13.0 | 13.4 | 17.0 | 58.8 | 48.8 | 26.0 | 24.5 | 10.0 | 12.0 | 75 | 43.00 |
| 4144 | SKP-S 120-10 | 120 mm ² | M10 | 10.0 | 15.5 | 19.0 | 69.0 | 56.6 | 29.0 | 28.0 | 13.0 | 14.5 | 50 | 58.00 |
| 4145 | SKP-S 120-12 | | M12 | 13.0 | 15.5 | 19.0 | 69.0 | 56.6 | 29.0 | 28.0 | 13.0 | 14.5 | 50 | 58.00 |
| 4146 | SKP-S 120-16 | | M16 | 17.0 | 15.5 | 19.0 | 69.0 | 56.6 | 29.0 | 28.0 | 13.0 | 14.5 | 50 | 63.50 |
| 4147 | SKP-S 150-10 | 150 mm ² | M10 | 10.5 | 16.5 | 16.5 | 76.5 | 60.0 | 30.0 | 30.0 | 16.5 | 16.5 | 40 | 90.00 |
| 4148 | SKP-S 150-12 | | M12 | 13.0 | 16.5 | 21.0 | 76.5 | 60.0 | 30.0 | 30.0 | 16.5 | 16.5 | 40 | 90.00 |
| 4149 | SKP-S 150-16 | | M16 | 17.0 | 16.5 | 21.0 | 76.5 | 60.0 | 30.0 | 30.0 | 16.5 | 16.5 | 40 | 90.00 |
| 4150 | SKP-S 185-12 | 185 mm ² | M12 | 13.0 | 5.5 | 23.0 | 82.5 | 65.5 | 33.0 | 34.0 | 17.0 | 18.0 | 30 | 115.00 |
| 4151 | SKP-S 185-16 | | M16 | 17.0 | 5.5 | 23.0 | 82.5 | 65.5 | 33.0 | 34.0 | 17.0 | 18.0 | 30 | 115.00 |
| 4152 | SKP-S 240-12 | 240 mm ² | M12 | 13.0 | 5.5 | 26.0 | 89.0 | 72.0 | 38.0 | 38.0 | 17.0 | 18.0 | 25 | 150.00 |
| 4153 | SKP-S 240-16 | | M16 | 17.0 | 5.5 | 26.0 | 89.0 | 72.0 | 38.0 | 38.0 | 17.0 | 18.0 | 25 | 150.00 |

BİMETALİK SIKMALI KABLO PAPUÇLARI

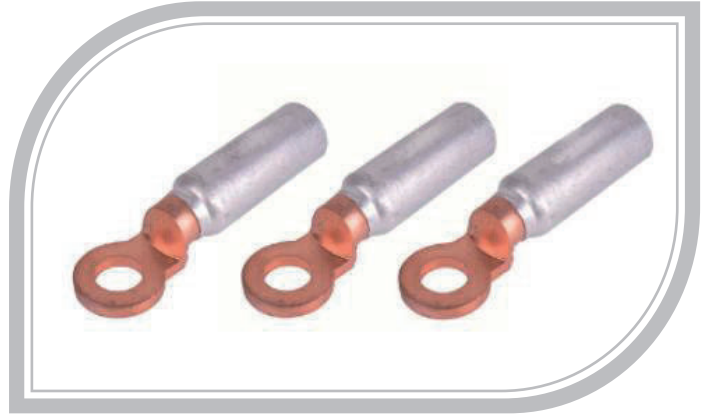

YENİ
ÜRÜN

| Sipariş Kodu | Ürün Kodu | Kablo Kesit (mm ²) | Delik Çapı Ø | Ebatlar (mm) | | Kutu Adet | Birim Fiyat USD / Adet |
|--------------|----------------|--------------------------------|-----------------|--------------|-------|-----------|------------------------|
| | | | | d | l | | |
| 7360 | JBM 16 | 16 | M12 | 13.0 | 84.0 | 100 | 3.33 |
| 7361 | JBM 25 | 25 | M12 | 13.0 | 84.0 | 100 | 3.33 |
| 7362 | JBM 35 | 35 | M12 | 13.0 | 84.0 | 100 | 3.33 |
| 7363 | JBM 50 | 50 | M12 | 13.0 | 84.0 | 50 | 4.25 |
| 7364 | JBM 70 | 70 | M12 | 13.0 | 84.0 | 50 | 4.25 |
| 7365 | JBM 95 | 95 | M12 | 13.0 | 84.0 | 50 | 4.25 |
| 7366 | JBM 120 | 120 | M12 | 13.0 | 107.0 | 20 | 7.10 |
| 7367 | JBM 150 | 150 | M12 | 13.0 | 107.0 | 20 | 7.10 |
| 7368 | JBM 185 | 185 | M12 | 13.0 | 117.0 | 12 | 11.90 |
| 7369 | JBM 240 | 240 | M12 | 13.0 | 117.0 | 12 | 11.90 |
| 7370 | JBM 300 | 300 | M16 | 17.0 | 135.0 | 12 | 16.00 |
| 7371 | JBM 400 | 400 | M16 | 17.0 | 135.0 | 5 | 29.80 |

EK MUFLARI

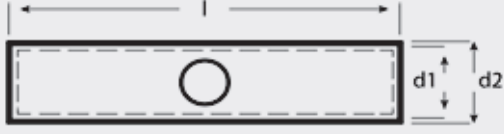

MALZEME: EN13600 Standart Bakır
YÜZEY: Kalay

| Sipariş Kodu | Ürün Kodu | Kablo Kesit (mm²) | Ebatlar (mm) | | | Kutu Adet | Birim Fiyat TL / Adet |
|--------------|--------------------|-------------------|--------------|------|------|-----------|-----------------------|
| | | | d1 | d2 | l | | |
| 4154 | EKMUF - 10 | 10 | 4.4 | 6.0 | 27.0 | 1000 | 4.60 |
| 4155 | EKMUF - 16 | 16 | 5.5 | 8.0 | 32.0 | 400 | 4.60 |
| 4156 | EKMUF - 25 | 25 | 7.0 | 9.0 | 40.5 | 250 | 9.00 |
| 4157 | EKMUF - 35 | 35 | 8.2 | 11.0 | 45.5 | 150 | 12.00 |
| 4158 | EKMUF - 50 | 50 | 9.5 | 13.5 | 53.5 | 90 | 16.00 |
| 4159 | EKMUF - 70 | 70 | 11.2 | 14.5 | 57.5 | 65 | 24.35 |
| 4160 | EKMUF - 95 | 95 | 13.4 | 17.0 | 61.5 | 50 | 30.00 |
| 4161 | EKMUF - 120 | 120 | 15.0 | 19.5 | 74.0 | 40 | 43.00 |
| 4162 | EKMUF - 150 | 150 | 16.5 | 21.0 | 79.0 | 25 | 65.00 |
| 4163 | EKMUF - 185 | 185 | 19.0 | 24.0 | 85.0 | 22 | 82.00 |
| 4164 | EKMUF - 240 | 240 | 21.0 | 26.0 | 94.0 | 18 | 120.50 |

U KLEMENS



| Sipariş Kodu | Ürün Kodu | Açıklama | Kutu Adet | Birim Fiyat TL / Adet |
|--------------|----------------|-----------------|-----------|-----------------------|
| 4165 | JUK 6 | 6mm U Klemens | 150 | 13.45 |
| 4166 | JUK 10 | 10mm U Klemens | 125 | 18.25 |
| 4167 | JUK 16 | 16mm U Klemens | 100 | 26.50 |
| 4168 | JUK 25 | 25mm U Klemens | 100 | 32.00 |
| 4169 | JUK 35 | 35mm U Klemens | 75 | 38.65 |
| 4170 | JUK 50 | 50mm U Klemens | 50 | 65.00 |
| 4171 | JUK 70 | 70mm U Klemens | 40 | 73.75 |
| 4172 | JUK 95 | 95mm U Klemens | 25 | 90.00 |
| 4173 | JUK 120 | 120mm U Klemens | 20 | 113.50 |
| 4174 | JUK 150 | 150mm U Klemens | 15 | 151.00 |

MONOFAZE MÜŞTEREK W OTOMAT BARALARI

| Sipariş Kodu | Ürün Kodu | Bakır Kalınlığı | Boy | Modül | Amper | Açıklama | Kutu Adet | Birim Fiyat TL / Adet |
|--------------|------------------|-----------------|--------|----------------|-------|---------------------------------|-----------|-----------------------|
| 4201 | M - 531 | 1 mm | 53 cm | 30 Otomat için | 80 A | Monofaze Müşterek W Otomat Bara | 50 | ☎ |
| 4202 | M - 1061 | 1 mm | 106 cm | 60 Otomat için | 80 A | Monofaze Müşterek W Otomat Bara | 50 | ☎ |
| 4203 | M - 5315 | 1.5 mm | 53 cm | 30 Otomat için | 100 A | Monofaze Müşterek W Otomat Bara | 50 | ☎ |
| 4204 | M - 10615 | 1.5 mm | 106 cm | 60 Otomat için | 100 A | Monofaze Müşterek W Otomat Bara | 50 | ☎ |

TRİFAZE MÜŞTEREK W OTOMAT BARALARI

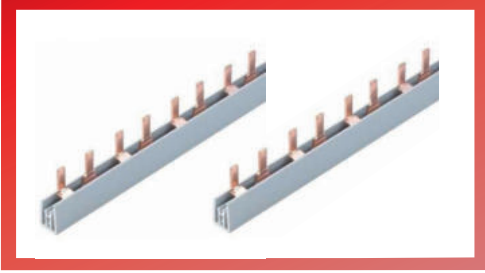

İSTEDİĞİNİZ ÖLÇÜDE KESİM YAPILIR.

| Sipariş Kodu | Ürün Kodu | Bakır Kalınlığı | Boy | Modül | Amper | Açıklama | Kutu Adet | Birim Fiyat TL / Adet |
|--------------|------------------|-----------------|--------|-----------------|-------|--------------------------------|-----------|-----------------------|
| 4205 | T - 221 | 1 mm | 22 cm | 4 Grup için | 80 A | Trifaze Müşterek W Otomat Bara | | ☎ |
| 4206 | T - 331 | 1 mm | 33 cm | 6 Grup için | 80 A | Trifaze Müşterek W Otomat Bara | | ☎ |
| 4207 | T - 441 | 1 mm | 44 cm | 8 Grup için | 80 A | Trifaze Müşterek W Otomat Bara | | ☎ |
| 4208 | T - 531 | 1 mm | 53 cm | 10 Grup için | 80 A | Trifaze Müşterek W Otomat Bara | 25 | ☎ |
| 4209 | T - 1061 | 1 mm | 106 cm | 20 Grup için | 80 A | Trifaze Müşterek W Otomat Bara | 25 | ☎ |
| 4210 | T - 2215 | 1.5 mm | 22 cm | 4 Grup için | 100 A | Trifaze Müşterek W Otomat Bara | | ☎ |
| 4211 | T - 3315 | 1.5 mm | 33 cm | 6 Grup için | 100 A | Trifaze Müşterek W Otomat Bara | | ☎ |
| 4212 | T - 4415 | 1.5 mm | 44 cm | 8 Grup için | 100 A | Trifaze Müşterek W Otomat Bara | | ☎ |
| 4213 | T - 5315 | 1.5 mm | 53 cm | 10 Grup için | 100 A | Trifaze Müşterek W Otomat Bara | 25 | ☎ |
| 4214 | T - 10615 | 1.5 mm | 106 cm | 20 Grup için | 100 A | Trifaze Müşterek W Otomat Bara | 25 | ☎ |
| 4215 | | | | Jameson - Kapak | | Bara Kapağı | 500 | ☎ |

MONTAJ RAYLARI

| Sipariş Kodu | Ürün Kodu | Açıklama | Uzunluk (m) | Kutu Adet | Birim Fiyat TL / Adet |
|--------------|---------------|-----------------------------|-------------|-----------|-----------------------|
| 4175 | JW-MR1 | 1mm Delikli Saç Montaj Rayı | 1 m | 50 | ☎ |
| 4176 | JW-MR2 | 1mm Delikli Saç Montaj Rayı | 2 m | 25 | ☎ |
| 4182 | JW-MR3 | Ray Taşıyıcı Saç | | 100 | ☎ |

NÖTR TOPRAKLAMA BARALAR

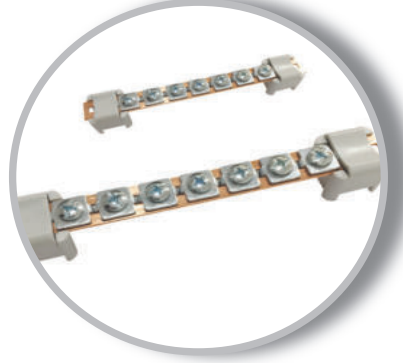

| Sipariş Kodu | Ürün Kodu | Bakır Kalınlığı | Uzunluk (m) | Kullanım Yeri | Kutu Adet | Birim Fiyat TL / Adet |
|--------------|--------------------------|-----------------|-------------|---------------|-----------|-----------------------|
| 4177 | JNTB-1.5-31 | 15mm x 1,5mm | 1 mt | 31 Vida | 50 | ☎ |
| 4178 | JNTB-1.5-61 | 15mm x 1,5mm | 1 mt | 61 Vida | 50 | ☎ |
| 4179 | JNTB-2-31 | 15mm x 2mm | 1 mt | 31 Vida | 50 | ☎ |
| 4180 | JNTB-2-61 | 15mm x 2mm | 1 mt | 61 Vida | 50 | ☎ |
| 4181 | Nötr Bara Mesneti | 15mm x 2mm | 1 mt | 31 Vida | 10 | ☎ |

RAYA MONTAJLI PRİZ

| Sipariş Kodu | Ürün Kodu | Açıklama | Kutu Adet | Birim Fiyat TL / Adet |
|--------------|------------|---|-----------|-----------------------|
| 4183 | JPP | Raya Montaj (Kapaklı) Pano Prizi (16A/250V) | 10 | 115.00 |

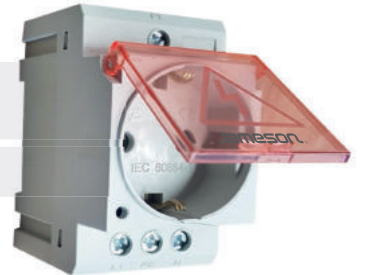

ERİYEN BANTLAR



| SİPARİŞ KODU | ÜRÜN KODU | ÖLÇÜLER | KOLİ ADET | Birim Fiyat USD / Ad. |
|--------------|----------------|----------------------|-----------|-----------------------|
| 5701 | JB-1401 | 19 mm x 0.8 mm x 8 m | 60 | 3.55 |
| 5702 | JB-1402 | 50 mm x 0.8 mm x 8 m | 24 | 9.50 |

PVC İZOLE BANT

| SİPARİŞ KODU | ÜRÜN KODU | ÖLÇÜLER | KOLİ ADET | Birim Fiyat USD / Ad. |
|--------------|-------------------|-------------------------|-----------|-----------------------|
| 5703 | İZOLE BANT | 0.50 mm x 50 mm x 9.1 m | 36 | |



JKS SERİSİ KAPI SİVİÇLERİ

| SİPARİŞ KODU | ÜRÜN KODU | KONTAK | AÇIKLAMA | KUTU ADET | KOLİ ADET | Birim Fiyat TL / Ad. |
|--------------|---------------|---------|---------------------------|-----------|-----------|----------------------|
| 5808 | JKS-10 | NO | Açık Kontak Kapı Sivici | 50 | 500 | 35.00 |
| 5809 | JKS-01 | NC | Kapalı Kontak Kapı Sivici | 50 | 500 | 37.00 |
| 5810 | JKS-12 | 1NO+1NC | (1NA+1NK) | 50 | 500 | 42.50 |

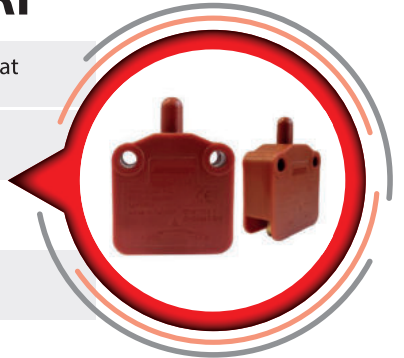

2 KUTUPLU DAĞITICI ÜNİTELER

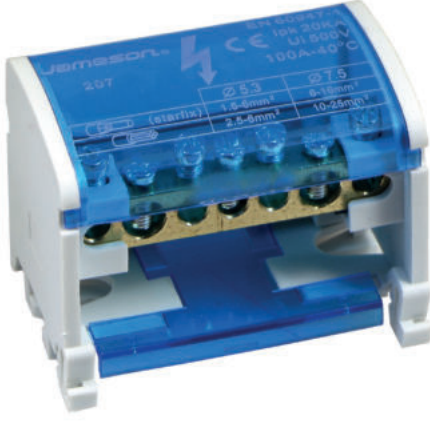

| | | |
|---------------------------------|-----------------------------|--|
| BİRİM FİYAT TL / AD | 122.00 | |
| SİPARİŞ KODU | 4301 | |
| ÜRÜN KODU | JD-2x7 | |
| AKIM | 125 Amper | |
| KABLO CİNSİ | Tek Damar | Çok Telli |
| | Giriş | Çıkış |
| KABLO KESİTİ (mm ²) | 1 x 10 - 35 mm ² | 1 x 10 - 25 mm ² 5 x 1,5 - 6 mm ² |
| | 1 x 10 - 16 mm ² | 1 x 6 - 16 mm ² 5 x 1,5 - 6 mm ² |
| Ambalaj Adet | Paket | Koli |
| | 1 | 138 |

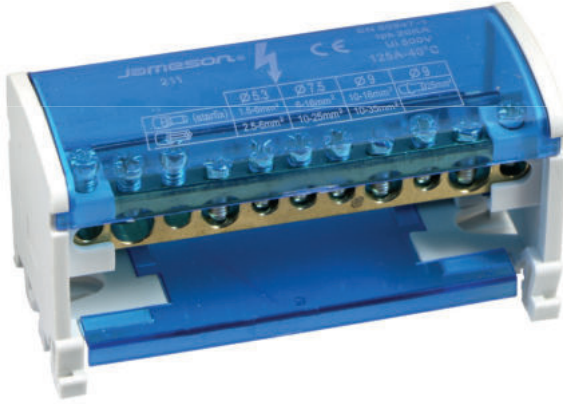

| | | |
|---------------------------------|-----------------------------|--|
| BİRİM FİYAT TL / AD | 175.00 | |
| SİPARİŞ KODU | 4302 | |
| ÜRÜN KODU | JD-2x11 | |
| AKIM | 125 Amper | |
| KABLO CİNSİ | Tek Damar | Çok Telli |
| | Giriş | Çıkış |
| KABLO KESİTİ (mm ²) | 2 x 10 - 35 mm ² | 2 x 10 - 25 mm ² 7 x 2,5 - 6 mm ² |
| | 2 x 10 - 16 mm ² | 2 x 6 - 16 mm ² 7 x 1,5 - 6 mm ² |
| Ambalaj Adet | Paket | Koli |
| | 1 | 84 |

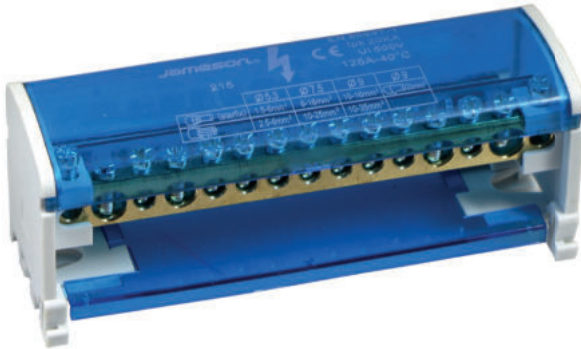

| | | |
|---------------------------------|-----------------------------|---|
| BİRİM FİYAT TL / AD | 227.00 | |
| SİPARİŞ KODU | 4303 | |
| ÜRÜN KODU | JD-2x15 | |
| AKIM | 125 Amper | |
| KABLO CİNSİ | Tek Damar | Çok Telli |
| | Giriş | Çıkış |
| KABLO KESİTİ (mm ²) | 2 x 10 - 35 mm ² | 2 x 10 - 25 mm ² 11 x 2,5 - 6 mm ² |
| | 2 x 10 - 16 mm ² | 2 x 6 - 16 mm ² 11 x 1,5 - 6 mm ² |
| Ambalaj Adet | Paket | Koli |
| | 1 | 72 |

4 KUTUPLU DAĞITICI ÜNİTELER



| | | |
|---------------------------------|-----------------------------|--|
| BİRİM FİYAT TL / AD | 227.00 | |
| SİPARİŞ KODU | 4304 | |
| ÜRÜN KODU | JD-4x7 | |
| AKIM | 125 Amper | |
| KABLO CİNSİ | Tek Damar | Çok Telli |
| | Giriş | Çıkış |
| KABLO KESİTİ (mm ²) | 1 x 10 - 35 mm ² | 1 x 10 - 25 mm ² 5 x 1,5 - 6 mm ² |
| | 1 x 10 - 16 mm ² | 1 x 6 - 16 mm ² 5 x 1,5 - 6 mm ² |
| Ambalaj Adet | Paket | Koli |
| | 1 | 74 |



| | | |
|---------------------------------|-----------------------------|--|
| BİRİM FİYAT TL / AD | 332.00 | |
| SİPARİŞ KODU | 4305 | |
| ÜRÜN KODU | JD-4x11 | |
| AKIM | 125 Amper | |
| KABLO CİNSİ | Tek Damar | Çok Telli |
| | Giriş | Çıkış |
| KABLO KESİTİ (mm ²) | 2 x 10 - 35 mm ² | 2 x 10 - 25 mm ² 7 x 2,5 - 6 mm ² |
| | 2 x 10 - 16 mm ² | 2 x 6 - 16 mm ² 7 x 1,5 - 6 mm ² |
| Ambalaj Adet | Paket | Koli |
| | 1 | 50 |



| | | |
|---------------------------------|-----------------------------|---|
| BİRİM FİYAT TL / AD | 424.00 | |
| SİPARİŞ KODU | 4306 | |
| ÜRÜN KODU | JD-4x15 | |
| AKIM | 125 Amper | |
| KABLO CİNSİ | Tek Damar | Çok Telli |
| | Giriş | Çıkış |
| KABLO KESİTİ (mm ²) | 2 x 10 - 35 mm ² | 2 x 10 - 25 mm ² 11 x 1,5 - 6 mm ² |
| | 2 x 10 - 16 mm ² | 2 x 6 - 16 mm ² 11 x 1,5 - 6 mm ² |
| Ambalaj Adet | Paket | Koli |
| | 1 | 40 |

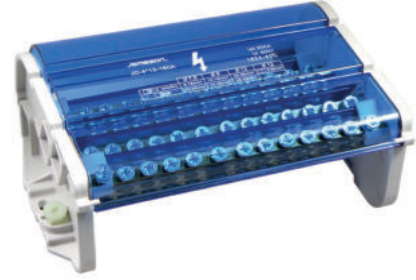

| | | |
|---------------------------------|-----------------------------|--|
| BİRİM FİYAT TL / AD | 996.00 | |
| SİPARİŞ KODU | 4307 | |
| ÜRÜN KODU | JD-4x12/160A | |
| AKIM | 160 Amper | |
| KABLO CİNSİ | Tek Damar | Çok Telli |
| | Giriş | Çıkış |
| KABLO KESİTİ (mm ²) | 1 x 10 - 50 mm ² | 3 x 10 - 25 mm ² 8 x 1,5 - 6 mm ² |
| | 1 x 10 - 50 mm ² | 3 x 6 - 16 mm ² 8 x 1,5 - 6 mm ² |
| Ambalaj Adet | Paket | Koli |
| | 1 | 18 |

TEK KUTUPLU DAĞITICI ÜNİTELER



| | | |
|---------------------------------|-----------------------------|---|
| BİRİM FİYAT TL / AD | 102.00 | |
| SİPARİŞ KODU | 4308 | |
| ÜRÜN KODU | JD-80A | |
| AKIM | 80 Amper | |
| KABLO CİNSİ | Tek Damar | Çok Telli |
| KABLO KESİTİ (mm ²) | Giriş | Çıkış |
| | 1 x 10 - 16 mm ² | 4 x 2,5 - 6 mm ² 2 x 2,5 - 16 mm ² |
| Ambalaj Adet | Paket | Koli |
| | 5 | 100 |



| | | |
|---------------------------------|-----------------------------|--|
| BİRİM FİYAT TL / AD | 212.00 | |
| SİPARİŞ KODU | 4309 | |
| ÜRÜN KODU | JD-125A | |
| AKIM | 125 Amper | |
| KABLO CİNSİ | Tek Damar | Çok Telli |
| KABLO KESİTİ (mm ²) | Giriş | Çıkış |
| | 1 x 10 - 35 mm ² | 6 x 2,5 - 16 mm ² Köprü 1 x 6 - 16 mm ² |
| Ambalaj Adet | Paket | Koli |
| | 5 | 75 |



| | | |
|---------------------------------|-----------------------------|--|
| BİRİM FİYAT TL / AD | 217.00 | |
| SİPARİŞ KODU | 4310 | |
| ÜRÜN KODU | JD-160A | |
| AKIM | 160 Amper | |
| KABLO CİNSİ | Tek Damar | Çok Telli |
| KABLO KESİTİ (mm ²) | Giriş | Çıkış |
| | 1 x 10 - 70 mm ² | 6 x 2,5 - 16 mm ² Köprü 2 x 2,5 - 16 mm ² |
| Ambalaj Adet | Paket | Koli |
| | 5 | 50 |

TEK KUTUPLU DAĞITICI ÜNİTELER



| | | |
|---------------------------------|------------------------------|--|
| BİRİM FİYAT TL / AD | 615.00 | |
| SİPARİŞ KODU | 4311 | |
| ÜRÜN KODU | JD-250A | |
| AKIM | 250 Amper | |
| KABLO CİNSİ | Tek Damar | Çok Telli |
| | Giriş | Çıkış |
| KABLO KESİTİ (mm ²) | 1 x 35 - 120 mm ² | 4 x 2,5 - 10 mm ² 5 x 2,5 - 16 mm ² 2 x 6 - 35 mm ² |
| | Paket | Koli |
| | Ambalaj Adet | 3 |



| | | |
|---------------------------------|------------------------------|--|
| BİRİM FİYAT TL / AD | 645.00 | |
| SİPARİŞ KODU | 4312 | |
| ÜRÜN KODU | JD-400A | |
| AKIM | 400 Amper | |
| KABLO CİNSİ | Tek Damar | Çok Telli |
| | Giriş | Çıkış |
| KABLO KESİTİ (mm ²) | 1 x 95 - 185 mm ² | 4 x 2,5 - 10 mm ² 5 x 2,5 - 16 mm ² 2 x 6 - 35 mm ² |
| | Paket | Koli |
| | Ambalaj Adet | 3 |



| | | |
|---------------------------------|------------------------|--|
| BİRİM FİYAT TL / AD | 699.00 | |
| SİPARİŞ KODU | 4313 | |
| ÜRÜN KODU | JD-500A | |
| AKIM | 500 Amper | |
| KABLO CİNSİ | Tek Damar | Çok Telli |
| | Giriş | Çıkış |
| KABLO KESİTİ (mm ²) | 8 x 24 mm ² | 4 x 2,5 - 10 mm ² 5 x 2,5 - 16 mm ² 2 x 6 - 35 mm ² |
| | Paket | Koli |
| | Ambalaj Adet | 3 |

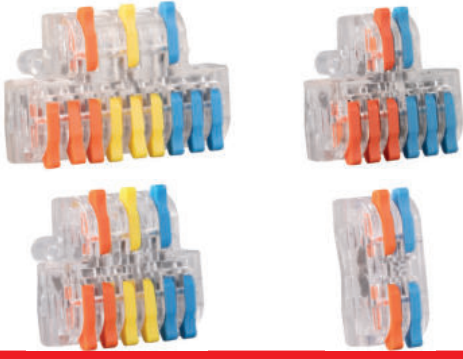

JAMESON[®]

ÇOK AMAÇLI KLEMENSLER

www.kivilcimelektrik.com.tr

GEÇMELİ BUAT KLEMENS

| Sipariş Kodu | Ürün Kodu | Renk | Kablo Kesiti | Ebatlar (mm) | | | Ambalaj Adet | | Birim Fiyat TL / Adet | |
|--------------|-----------------|---------|----------------------------|--------------|------|-----------|--------------|--------|-----------------------|---|
| | | | | En | Boy | Yükseklik | Paket | Koli | | |
| 4401 | JW 2.5-2 | Beyaz | 0.50 - 2.5 mm ² | 9.8 | 16.4 | 5.8 | 200 | 10.000 | 2.64 |  |
| 4402 | JW 2.5-3 | Turuncu | 0.50 - 2.5 mm ² | 13.9 | 16.4 | 5.8 | 200 | 10.000 | 2.84 |  |
| 4403 | JW 2,5 4 | Kırmızı | 0.50 - 2.5 mm ² | 17.9 | 16.4 | 5.8 | 100 | 5000 | 3.36 |  |
| 4404 | JW 2,5-5 | Sarı | 0.50 - 2.5 mm ² | 21.9 | 16.4 | 5.8 | 100 | 5000 | 3.68 |  |
| 4405 | JW 2,5-6 | Kırmızı | 0.50 - 2.5 mm ² | 13.8 | 16.4 | 11.25 | 100 | 5000 | 4.52 |  |
| 4406 | JW 2,5-8 | Gri | 0.50 - 2.5 mm ² | 17.8 | 16.4 | 11.25 | 100 | 5000 | 5.68 |  |

ÇOK AMAÇLI KLEMENS

| Sipariş Kodu | Ürün Kodu | Kablo Kesiti | Açıklama | Ambalaj Adet | | Birim Fiyat TL / Adet | |
|--------------|---------------|----------------------------|----------------------|--------------|------|-----------------------|---|
| | | | | Paket | Koli | | |
| 4407 | JW-412 | 0.14 - 4.0 mm ² | 2 İletken Bağlantılı | 100 | 5000 | 5.05 |  |
| 4408 | JW-413 | 0.14 - 4.0 mm ² | 3 İletken Bağlantılı | 100 | 5000 | 6.62 |  |
| 4409 | JW-414 | 0.14 - 4.0 mm ² | 4 İletken Bağlantılı | 50 | 2500 | 8.10 |  |
| 4410 | JW-415 | 0.14 - 4.0 mm ² | 5 İletken Bağlantılı | 50 | 2500 | 9.54 |  |

ÇALIŞMA SICAKLIĞI: -40 °C «» 100 °C **NOMİNAL AKIM:** 32A **NOMİNAL GERİLİM:** 450V

DAĞITICILI BUAT KLEMENS

YENİ
ÜRÜN

| Sipariş Kodu | Ürün Kodu | Renk | Kablo Kesiti | Ebatlar (mm) | | | Ambalaj Adet | | Birim Fiyat TL / Adet | |
|--------------|--------------------|-------|----------------------------|--------------|------|-----------|--------------|------|-----------------------|---|
| | | | | En | Boy | Yükseklik | Paket | Koli | | |
| 7745 | JCT 2-2 | Beyaz | 0.50 - 2.5 mm ² | 13.6 | 40.3 | 14.5 | 50 | 2000 | 9.25 |  |
| 7746 | JCT 3-3 | Beyaz | 0.50 - 2.5 mm ² | 18.6 | 40.3 | 14.5 | 50 | 2000 | 12.75 |  |
| 7747 | JDK T22 | Beyaz | 0.50 - 2.5 mm ² | 13.0 | 43.0 | 13.4 | 50 | 2000 | 31.50 |  |
| 7748 | JDK T42 | Beyaz | 0.50 - 2.5 mm ² | 23-13 | 31.5 | 13.5 | 50 | 2000 | 42.00 |  |
| 7749 | JDK - 42 | Beyaz | 0.50 - 2.5 mm ² | 23-13 | 31.5 | 13.5 | 50 | 2000 | 17.00 |  |
| 7750 | JDK - 62 | Beyaz | 0.50 - 2.5 mm ² | 33-13 | 31.5 | 13.5 | 40 | 2000 | 29.75 |  |
| 7751 | JDK - 63 | Beyaz | 0.50 - 2.5 mm ² | 33-13 | 31.5 | 13.5 | 30 | 1000 | 30.55 |  |
| 7751 | JDK - 93 | Beyaz | 0.50 - 2.5 mm ² | 48-28 | 31.5 | 3.5 | 30 | 1000 | 38.50 |  |
| 7752 | JRJ45- CAT6 | Beyaz | | | | | 100 | 1000 | 1.95 |  |

NOMİNAL AKIM: 32A NOMİNAL GERİLİM: 450V

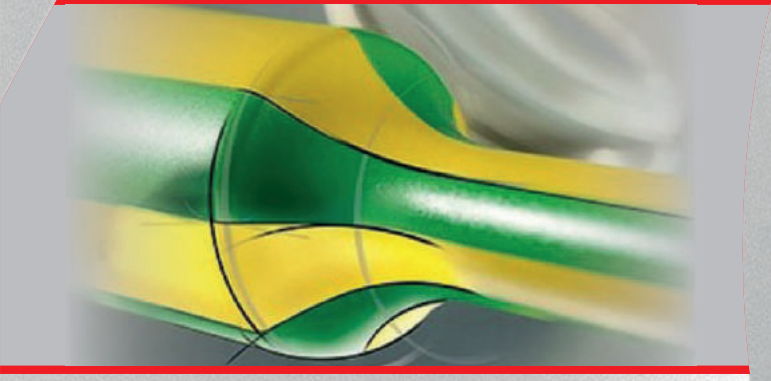

JAMESON®

**MAKARON
ÇEŞİTLERİ ve KABLO
TOPLAMA ÇORAPLARI**

www.kivilcimelektrik.com.tr

ISI İLE DARALAN SİYAH MAKARONLAR

| Sipariş Kodu | Ölçü | | Daralmadan Önce (mm) | | Daralmadan Sonra (mm) | | Makara / Mt. | Koli Miktarı | Birim Fiyatı USD / Mt. |
|--------------|---------|------|----------------------|-----------------|-----------------------|-----------------|--------------|--------------|------------------------|
| | Inch | mm | İç Çap | Cidar Kalınlığı | İç Çap | Cidar Kalınlığı | | | |
| 5015 | — | 1 | 2.0 ± 0.3 | 0.16 ± 0.05 | 0.70 | 0.30 ± 0.05 | 200 | 3200 | 0.085 |
| 5016 | — | 1.5 | 2.0 ± 0.3 | 0.16 ± 0.05 | 0.80 | 0.30 ± 0.05 | 200 | 2400 | 0.097 |
| 5017 | — | 2 | 2.5 ± 0.3 | 0.16 ± 0.05 | 1.00 | 0.35 ± 0.05 | 200 | 3000 | 0.115 |
| 5018 | 3/32 | 2.4 | 3.0 ± 0.3 | 0.16 ± 0.05 | 1.50 | 0.35 ± 0.05 | 200 | 3000 | 0.115 |
| 5019 | — | 2.5 | 3.0 ± 0.3 | 0.16 ± 0.05 | 1.25 | 0.38 ± 0.05 | 200 | 2600 | 0.15 |
| 5020 | — | 3 | 3.4 ± 0.4 | 0.20 ± 0.05 | 1.50 | 0.38 ± 0.05 | 200 | 2200 | 0.16 |
| 5021 | 1/8 | 3.2 | 3.5 ± 0.4 | 0.20 ± 0.05 | 1.75 | 0.40 ± 0.05 | 200 | 2200 | 0.16 |
| 5022 | — | 3.5 | 4.0 ± 0.4 | 0.20 ± 0.05 | 1.75 | 0.40 ± 0.05 | 200 | 1800 | 0.17 |
| 5023 | — | 4 | 4.5 ± 0.4 | 0.20 ± 0.05 | 2.00 | 0.45 ± 0.05 | 200 | 1400 | 0.20 |
| 5024 | — | 4.5 | 4.8 ± 0.4 | 0.20 ± 0.05 | 2.00 | 0.47 ± 0.08 | 100 | 1000 | 0.23 |
| 5025 | 3/16 | 4.8 | 5.2 ± 0.4 | 0.20 ± 0.05 | 2.60 | 0.47 ± 0.08 | 100 | 1000 | 0.23 |
| 5026 | — | 5 | 5.5 ± 0.4 | 0.20 ± 0.05 | 2.50 | 0.55 ± 0.08 | 100 | 900 | 0.25 |
| 5027 | — | 6 | 6.5 ± 0.4 | 0.22 ± 0.05 | 3.00 | 0.55 ± 0.05 | 100 | 700 | 0.29 |
| 5028 | 1/4 | 6.4 | 7.0 ± 0.4 | 0.28 ± 0.05 | 3.50 | 0.55 ± 0.08 | 100 | 700 | 0.29 |
| 5029 | — | 7 | 7.5 ± 0.4 | 0.28 ± 0.05 | 3.50 | 0.60 ± 0.08 | 100 | 500 | 0.35 |
| 5030 | — | 8 | 8.5 ± 0.4 | 0.30 ± 0.08 | 4.00 | 0.60 ± 0.08 | 100 | 1300 | 0.35 |
| 5031 | 3/8 | 9.5 | 10.0 ± 0.5 | 0.30 ± 0.08 | 5.00 | 0.60 ± 0.08 | 100 | 1200 | 0.35 |
| 5032 | — | 10 | 10.0 ± 0.5 | 0.30 ± 0.08 | 5.00 | 0.60 ± 0.08 | 100 | 1100 | 0.39 |
| 5033 | 1/2 | 12.7 | 13.0 ± 0.5 | 0.33 ± 0.10 | 6.50 | 0.65 ± 0.08 | 100 | 1000 | 0.45 |
| 5034 | — | 13 | 13.5 ± 0.5 | 0.33 ± 0.10 | 6.50 | 0.65 ± 0.08 | 100 | 900 | 0.48 |
| 5035 | — | 14 | 14.5 ± 0.5 | 0.33 ± 0.10 | 7.00 | 0.70 ± 0.08 | 100 | 900 | 0.56 |
| 5036 | 4/5 | 16 | 16.5 ± 0.6 | 0.35 ± 0.12 | 8.00 | 0.75 ± 0.08 | 100 | 800 | 0.75 |
| 5037 | — | 18 | 19.0 ± 0.6 | 0.40 ± 0.15 | 9.00 | 0.80 ± 0.15 | 100 | 700 | 0.98 |
| 5038 | 3/4 | 19.1 | 20.5 ± 0.6 | 0.40 ± 0.15 | 10.00 | 0.80 ± 0.15 | 100 | 700 | 0.98 |
| 5039 | — | 20 | 20.5 ± 0.6 | 0.40 ± 0.15 | 10.00 | 0.80 ± 0.15 | 100 | 600 | 1.25 |
| 5040 | — | 22 | 22.5 ± 0.7 | 0.45 ± 0.15 | 12.00 | 0.95 ± 0.15 | 100 | 600 | 1.55 |
| 5041 | 1 | 25.4 | 25.6 ± 0.7 | 0.45 ± 0.15 | 12.00 | 0.95 ± 0.15 | 50 | 300 | 1.65 |
| 5042 | — | 30 | 31.5 ± 0.7 | 0.50 ± 0.15 | 15.00 | 0.95 ± 0.15 | 50 | 250 | 2.15 |
| 5043 | 1 — 1/4 | 32 | 33.0 ± 0.7 | 0.50 ± 0.15 | 16.50 | 0.95 ± 0.15 | 50 | 250 | 2.15 |
| 5044 | — | 35 | 38.0 ± 0.7 | 0.50 ± 0.15 | 16.00 | 1.00 ± 0.15 | 50 | 200 | 2.70 |
| 5045 | 1 — 1/2 | 38 | 40.0 ± 0.7 | 0.50 ± 0.15 | 20.00 | 1.00 ± 0.15 | 50 | 200 | 3.00 |
| 5046 | — | 40 | 40.5 ± 0.7 | 0.50 ± 0.15 | 20.00 | 1.00 ± 0.15 | 50 | 200 | 3.00 |
| 5047 | 2 | 51 | 52.5 ± 0.7 | 0.50 ± 0.15 | 25.00 | 1.00 ± 0.15 | 25 | 125 | 3.80 |
| 5048 | — | 60 | 60.5 ± 0.8 | 0.52 ± 0.15 | 30.00 | 1.00 ± 0.16 | 25 | 100 | 5.10 |
| 5049 | — | 70 | 70.5 ± 1.0 | 0.55 ± 0.15 | 40.00 | 1.10 ± 0.18 | 25 | 75 | 6.80 |
| 5050 | — | 80 | 82.0 ± 1.0 | 0.55 ± 0.15 | 40.00 | 1.10 ± 0.18 | 25 | 75 | 7.50 |
| 5051 | — | 90 | 90.0 ± 1.0 | 0.55 ± 0.15 | 45.00 | 1.10 ± 0.18 | 25 | 50 | 8.50 |
| 5052 | 4 | 102 | 105.0 ± 1.0 | 0.55 ± 0.15 | 51.00 | 1.10 ± 0.18 | 25 | 50 | 9.50 |
| 5053 | — | 120 | 120.0 ± 1.0 | 0.55 ± 0.15 | 60.00 | 1.10 ± 0.18 | 25 | 50 | 13.00 |
| 5054 | — | 150 | 150.0 ± 1.0 | 0.55 ± 0.15 | 76.00 | 1.10 ± 0.18 | 25 | 50 | 19.00 |
| 5055 | — | 180 | 180.0 ± 1.0 | 0.55 ± 0.15 | 90.00 | 1.10 ± 0.18 | 25 | 25 | 27.00 |

ÇALIŞMA SICAKLIĞI: -55 °C «» +125 °C **MALZEME:** Polyolefin **Daralma Oranı:** 2/1 **Yanmazlık:** Kendi kendine söner

ISI İLE DARALAN RENKLİ MAKARONLAR

ŞEFFAF - BEYAZ - KIRMIZI - MAVİ - SARI - YEŞİL - GRİ

TEKNİK ÖZELLİKLER

Malzeme : Polyolefin

Daralma Oranı : 2/1

Yanmazlık : Kendi kendine söner

Çalışma Sıcaklığı : -55°C -- +125°C



| Ölçü | | Sipariş Kodu | | | | | | | Makara / Mt. | Koli Miktarı | Fiyat USD / Mt. |
|---------|------|--------------|-------|---------|------|------|-------|------|--------------|--------------|-----------------|
| Inch | mm | ŞEFFAF | BEYAZ | KIRMIZI | MAVİ | SARI | YEŞİL | GRİ | | | |
| — | 1.5 | 5101 | 5117 | 5138 | 5154 | 5175 | 5195 | 5211 | 200 | 3.200 | 0.11 |
| — | 2.5 | 5102 | 5118 | 5139 | 5155 | 5305 | 5196 | 5212 | 200 | 2.600 | 0.17 |
| 1/8 | 3.2 | 5103 | 5119 | 5140 | 5156 | 5176 | 5197 | 5213 | 200 | 2.200 | 0.20 |
| — | 3.5 | — | 5120 | — | 5157 | 5177 | — | — | 200 | 1.800 | 0.21 |
| Yassı | 3.5 | — | 5121 | — | 5158 | 5178 | — | — | 100 | 1.600 | 0.21 |
| 3/16 | 4.8 | 5104 | 5122 | 5141 | 5159 | 5179 | 5198 | 5214 | 100 | 1.000 | 0.27 |
| Yassı | 4.8 | — | 5123 | — | 5160 | 5180 | — | — | 100 | 1.500 | 0.27 |
| 1/4 | 6.4 | 5105 | 5124 | 5142 | 5161 | 5181 | 5199 | 5215 | 100 | 700 | 0.33 |
| Yassı | 6.4 | — | 5125 | — | 5162 | 5182 | — | — | 100 | 1.500 | 0.33 |
| Yassı | 7 | — | 5126 | — | 5163 | 5183 | — | — | 100 | 1.400 | 0.33 |
| 3/8 | 9.5 | 5106 | 5127 | 5143 | 5164 | 5184 | 5200 | 5216 | 100 | 1.200 | 0.39 |
| — | 13 | 5107 | 5128 | 5144 | 5165 | 5185 | 5201 | 5217 | 100 | 900 | 0.55 |
| 4/5 | 16 | 5108 | 5129 | 5145 | 5166 | 5186 | 5202 | 5218 | 100 | 800 | 0.85 |
| — | 20 | 5109 | 5130 | 5146 | 5167 | 5187 | 5203 | 5219 | 100 | 600 | 1.50 |
| 1 | 25.4 | 5110 | 5131 | 5147 | 5168 | 5188 | 5204 | 5220 | 50 | 300 | 1.90 |
| 1 - 1/4 | 32 | 5111 | 5132 | 5148 | 5169 | 5189 | 5205 | 5221 | 50 | 250 | 2.40 |
| 1 - 1/2 | 38 | 5112 | 5133 | 5149 | 5170 | 5190 | 5206 | 5222 | 50 | 200 | 3.60 |
| 2 | 51 | 5113 | 5134 | 5150 | 5171 | 5191 | 5207 | 5223 | 25 | 125 | 4.20 |
| — | 60 | 5114 | 5135 | 5151 | 5172 | 5192 | 5208 | 5224 | 25 | 100 | 5.80 |
| — | 80 | 5115 | 5136 | 5152 | 5173 | 5193 | 5209 | 5225 | 25 | 75 | 8.00 |
| 4 | 102 | 5116 | 5137 | 5153 | 5174 | 5194 | 5210 | 5226 | 25 | 50 | 11.00 |

ISI İLE DARALAN RENKLİ MAKARONLAR

KAHVERENGİ- TURUNCU - MOR

TEKNİK ÖZELLİKLER

Malzeme : Polyolefin

Daralma Oranı : 2/1

Yanmazlık : Kendi kendine söner

Çalışma Sıcaklığı : -55°C -- +125°C



| Ölçü | | Sipariş Kodu | | | Makara / Mt. | Koli Miktarı | Fiyat USD / Mt. |
|---------|------|--------------|---------|------|--------------|--------------|-----------------|
| Inch | mm | KAHVERENGİ | TURUNCU | MOR | | | |
| — | 1.5 | 5227 | 5243 | 5259 | 200 | 3.200 | 0.12 |
| — | 2.5 | 5228 | 5244 | 5260 | 200 | 2.600 | 0.18 |
| 1/8 | 3.2 | 5229 | 5245 | 5261 | 200 | 2.200 | 0.22 |
| 3/16 | 4.8 | 5230 | 5246 | 5262 | 100 | 1.000 | 0.29 |
| 1/4 | 6.4 | 5231 | 5247 | 5263 | 100 | 700 | 0.38 |
| 3/8 | 9.5 | 5232 | 5248 | 5264 | 100 | 1.200 | 0.44 |
| — | 13 | 5233 | 5249 | 5265 | 100 | 900 | 0.60 |
| 4/5 | 16 | 5234 | 5250 | 5266 | 100 | 800 | 1.05 |
| — | 20 | 5235 | 5251 | 5267 | 100 | 600 | 1.55 |
| 1 | 25.4 | 5236 | 5252 | 5268 | 50 | 300 | 2.10 |
| 1 - 1/4 | 32 | 5237 | 5253 | 5269 | 50 | 250 | 2.80 |
| 1 - 1/2 | 38 | 5238 | 5254 | 5270 | 50 | 200 | 4.10 |
| 2 | 51 | 5239 | 5255 | 5271 | 25 | 125 | 4.90 |
| — | 60 | 5240 | 5256 | 5272 | 25 | 100 | 7.50 |
| — | 80 | 5241 | 5257 | 5273 | 25 | 75 | 9.00 |
| 4 | 102 | 5242 | 5258 | 5274 | 25 | 50 | 13.50 |

ISI İLE DARALAN MAKARONLAR

SARI YEŞİL

TEKNİK ÖZELLİKLER

Malzeme : Polyolefin

Daralma Oranı : 2/1

Yanmazlık : Kendi kendine söner

Çalışma Sıcaklığı : -55°C -- +125°C



| Sipariş Kodu | Ölçü | | Daralmadan Önce (mm) | | Daralmadan Sonra (mm) | | Makara / Mt. | Koli Miktarı | Fiyat USD / Mt. |
|--------------|---------|------|----------------------|-----------------|-----------------------|-----------------|--------------|--------------|-----------------|
| | Inch | mm | İç Çap | Cidar Kalınlığı | İç Çap | Cidar Kalınlığı | | | |
| 5275 | 3/32 | 2.4 | 3.0 ± 0.3 | 0.16 ± 0.05 | 1.50 | 0.35 ± 0.05 | 200 | 3.000 | 0.42 |
| 5276 | 1/8 | 3.2 | 3.5 ± 0.4 | 0.20 ± 0.05 | 1.75 | 0.40 ± 0.05 | 200 | 2.200 | 0.43 |
| 5277 | 3/16 | 4.8 | 5.2 ± 0.4 | 0.20 ± 0.05 | 2.60 | 0.47 ± 0.08 | 100 | 1.000 | 0.44 |
| 5278 | 1/4 | 6.4 | 7.0 ± 0.4 | 0.28 ± 0.05 | 3.50 | 0.55 ± 0.08 | 100 | 700 | 0.50 |
| 5279 | 3/8 | 9.5 | 10.0 ± 0.5 | 0.30 ± 0.08 | 5.00 | 0.65 ± 0.08 | 100 | 1.200 | 0.68 |
| 5280 | — | 13 | 13.5 ± 0.5 | 0.33 ± 0.10 | 6.50 | 0.75 ± 0.08 | 100 | 900 | 1.00 |
| 5281 | 4/5 | 16 | 16.5 ± 0.6 | 0.35 ± 0.12 | 8.00 | 0.80 ± 0.15 | 100 | 800 | 1.45 |
| 5282 | — | 20 | 20.5 ± 0.6 | 0.40 ± 0.15 | 10.00 | 0.95 ± 0.15 | 100 | 600 | 1.90 |
| 5283 | 1 | 25.4 | 25.6 ± 0.7 | 0.45 ± 0.15 | 12.00 | 0.95 ± 0.15 | 50 | 300 | 2.75 |
| 5284 | 1 - 1/4 | 32 | 33.0 ± 0.7 | 0.50 ± 0.15 | 16.50 | 1.00 ± 0.15 | 50 | 250 | 3.70 |
| 5285 | 1 - 1/2 | 38 | 40.0 ± 0.7 | 0.50 ± 0.15 | 20.00 | 1.00 ± 0.15 | 50 | 200 | 5.00 |
| 5286 | 2 | 51 | 52.5 ± 0.7 | 0.50 ± 0.15 | 25.00 | 1.00 ± 0.15 | 50 | 125 | 7.00 |
| 5287 | — | 60 | 60.5 ± 0.8 | 0.52 ± 0.15 | 30.00 | 1.00 ± 0.16 | 25 | 100 | 10.00 |
| 5288 | — | 80 | 82.5 ± 1.0 | 0.55 ± 0.15 | 40.00 | 1.00 ± 0.18 | 25 | 75 | 15.00 |
| 5289 | 4 | 102 | 105.0 ± 1.0 | 0.55 ± 0.15 | 51.00 | 1.00 ± 0.18 | 25 | 50 | 23.00 |

İÇİ YAPIŞKANLI BORU TİPİ MAKARONLAR

| Sipariş Kodu | Ölçü | Daralmadan Önce (mm) | | Daralmadan Sonra (mm) | | Makara / Mt. | Koli Miktarı | Fiyat USD / Mt. |
|--------------|---------|----------------------|--------------|-----------------------|-------------------|--------------|--------------|-----------------|
| | | İç Çap | Azami İç Çap | Anma Çıdar Kalınlığı | Anma Yapışkanlığı | | | |
| 5290 | 3/1 | 3 | 1.00 | 1.10 ± 0.10 | 0.50 | 200 | 1.800 | 0,65 |
| 5291 | 4.8/1.5 | 4.8 | 1.50 | 1.20 ± 0.10 | 0.50 | 100 | 900 | 0,80 |
| 5292 | 6.2 | 6 | 2.00 | 1.30 ± 0.10 | 0.50 | 100 | 600 | 1.20 |
| 5293 | 9/3 | 9 | 3.00 | 1.70 ± 0.15 | 0.60 | 50 | 300 | 1.60 |
| 5294 | 12/4 | 12 | 4.00 | 2.00 ± 0.20 | 0.80 | 1.20 Boy | 250 | 2,30 |
| 5295 | 16/5 | 16 | 5.00 | 2.20 ± 0.20 | 0.80 | 1.20 Boy | 250 | 3.20 |
| 5296 | 19/6 | 19 | 6.00 | 2.30 ± 0.20 | 0.80 | 1.20 Boy | 150 | 4.50 |
| 5297 | 28/9 | 28 | 9.00 | 2.40 ± 0.20 | 1.05 | 1.20 Boy | 110 | 5.10 |
| 5298 | 33/10 | 33 | 10.00 | 2.50 ± 0.20 | 1.05 | 1.20 Boy | 100 | 5.80 |
| 5299 | 40/12 | 40 | 12.00 | 2.50 ± 0.20 | 1.05 | 1.20 Boy | 90 | 6.40 |
| 5300 | 44/14 | 44 | 14.00 | 2.50 ± 0.20 | 1.05 | 1.20 Boy | 60 | 7.10 |
| 5301 | 52/18 | 52 | 18.00 | 2.50 ± 0.20 | 1.05 | 1.20 Boy | 60 | 8.00 |
| 5302 | 70/25 | 70 | 25.00 | 3.00 ± 0.30 | 1.35 | 1.20 Boy | 32 | 11.30 |
| 5303 | 90/30 | 90 | 30.00 | 3.00 ± 0.30 | 1.35 | 1.20 Boy | 24 | 16.00 |
| 5304 | 125/40 | 125 | 40.00 | 3.00 ± 0.30 | 1.35 | 1.20 Boy | 20 | 20.00 |

MAKARONLAR TEKNİK ÖZELLİKLER

Malzeme : Polyolefin

Daralma Oranı : 3/1

Yanmazlık : Kendi kendine söner

Çalışma Sıcaklığı : -55°C -- +125°C

İÇİ
YAPIŞKANLI
BORU
TİPİ



H CLASS CAM ELYAF SİLİKON İZOLELİ MAKARONLAR

| Sipariş Kodu | Ölçü | Renk | Makara / Mt. | Koli Miktarı | Fiyat USD / Mt. |
|--------------|-------|---------|--------------|--------------|-----------------|
| 5401 | 1 mm | Kırmızı | 200 | 2.600 | 0.23 |
| 5402 | 2 mm | Kırmızı | 200 | 2.600 | 0.25 |
| 5403 | 3 mm | Kırmızı | 100 | 2.000 | 0.38 |
| 5404 | 4 mm | Kırmızı | 100 | 1.500 | 0.52 |
| 5405 | 5 mm | Kırmızı | 100 | 1.000 | 0.62 |
| 5406 | 6 mm | Kırmızı | 100 | 1.000 | 0.77 |
| 5407 | 7 mm | Kırmızı | 100 | 1.000 | 0.88 |
| 5408 | 8 mm | Kırmızı | 50 | 1.000 | 1.00 |
| 5409 | 10 mm | Kırmızı | 50 | 600 | 1.37 |
| 5410 | 12 mm | Kırmızı | 50 | 500 | 1.70 |
| 5411 | 14 mm | Kırmızı | 50 | 500 | 2.05 |
| 5412 | 16 mm | Kırmızı | 25 | 400 | 2.70 |
| 5413 | 18 mm | Kırmızı | 25 | 400 | 3.50 |
| 5414 | 20 mm | Kırmızı | 25 | 350 | 4.50 |
| 5415 | 25 mm | Kırmızı | 25 | 150 | 8.50 |
| 5416 | 30 mm | Kırmızı | 25 | 150 | 12.50 |
| 5417 | 35 mm | Kırmızı | 25 | 150 | 15.00 |

TEKNİK ÖZELLİKLER

MALZEME: Silikon İzoleli Cam Elyaf Örgü Makaron

ÇALIŞMA SICAKLIĞI: -60 °C «» +250 °C



PVC İZOLELİ CAM ELYAF MAKARONLAR

| Sipariş Kodu | Ölçü | Renk | Makara / Mt. | Koli Miktarı | Fiyat USD / Mt. |
|--------------|-------|---------------------|--------------|--------------|-----------------|
| 5501 | 1 mm | Beyaz Üzeri Çizgili | 200 | 2.400 | 0.15 |
| 5502 | 2 mm | Beyaz Üzeri Çizgili | 200 | 2.400 | 0.19 |
| 5503 | 3 mm | Beyaz Üzeri Çizgili | 100 | 2.400 | 0.24 |
| 5504 | 4 mm | Beyaz Üzeri Çizgili | 100 | 2.000 | 0.33 |
| 5505 | 5 mm | Beyaz Üzeri Çizgili | 100 | 1.400 | 0.40 |
| 5506 | 6 mm | Beyaz Üzeri Çizgili | 100 | 1.300 | 0.45 |
| 5507 | 7 mm | Beyaz Üzeri Çizgili | 100 | 1.200 | 0.50 |
| 5508 | 8 mm | Beyaz Üzeri Çizgili | 100 | 1.000 | 0.68 |
| 5509 | 10 mm | Beyaz Üzeri Çizgili | 50 | 1.000 | 0.85 |
| 5510 | 12 mm | Beyaz Üzeri Çizgili | 50 | 1.000 | 0.95 |
| 5511 | 14 mm | Beyaz Üzeri Çizgili | 50 | 650 | 1.35 |
| 5512 | 16 mm | Beyaz Üzeri Çizgili | 50 | 600 | 1.42 |
| 5513 | 18 mm | Beyaz Üzeri Çizgili | 50 | 400 | 1.50 |
| 5514 | 20 mm | Beyaz Üzeri Çizgili | 25 | 400 | 2.97 |

TEKNİK ÖZELLİKLER

MALZEME: PVC İzoleli Cam Elyaf Makaron

ÇALIŞMA SICAKLIĞI: -20 °C «» +130 °C



KABLO TOPLAMA ÇORABI

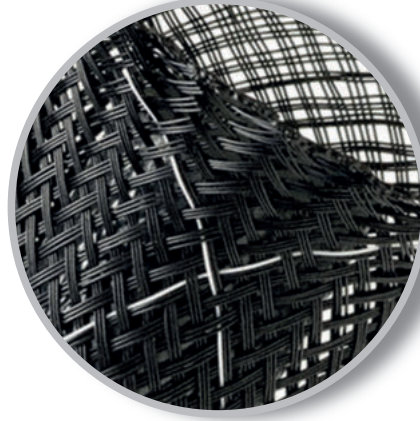

TEKNİK ÖZELLİKLER

MALZEME: Pet (Polyester)

ÇALIŞMA SICAKLIĞI: -50 °C «» +150 °C

DAYANIM ÜST NOKTASI: 220 °C

ERİME NOKTASI: +250 °C

| Sipariş Kodu | Ölçü | Renk | Esneleme Aralığı | | Makara / Mt. | Fiyat USD / Mt. |
|--------------|-------|-------|------------------|----------|--------------|-----------------|
| | | | Min (mm) | Max (mm) | | |
| 5601 | 3 mm | Siyah | 1 | 6 | 100 | 0.24 |
| 5602 | 6 mm | Siyah | 3 | 9 | 100 | 0.29 |
| 5603 | 8 mm | Siyah | 5 | 16 | 100 | 0.30 |
| 5604 | 10 mm | Siyah | 7 | 19 | 100 | 0.36 |
| 5605 | 12 mm | Siyah | 8 | 24 | 100 | 0.43 |
| 5606 | 15 mm | Siyah | 10 | 27 | 100 | 0.48 |
| 5607 | 20 mm | Siyah | 14 | 30 | 100 | 0.56 |
| 5608 | 25 mm | Siyah | 18 | 35 | 100 | 0.72 |
| 5609 | 30 mm | Siyah | 20 | 50 | 50 | 0.87 |
| 5610 | 40 mm | Siyah | 30 | 60 | 50 | 1.14 |
| 5611 | 50 mm | Siyah | 40 | 80 | 25 | 1.40 |



JAMESON[®]

MEKANİK VE HİDROLİK EL ALETLERİ

www.kivilcimelektrik.com.tr

YÜKSÜK SIKMA PENSELERİ / MEKANİK EL ALETLERİ

Sipariş Kodu: 6001

T-007

0.5-10 mm² Yüksük Sıkma Pensesi



135.00
USD

Sipariş Kodu: 6002

AN-03C

0.5-6 mm² Yüksük Sıkma Pensesi



68.00
USD

Sipariş Kodu: 6003

AN-004

0.5-10 mm² İzolesiz Kablo Ucu Sıkma Pensesi



60.00
USD

Sipariş Kodu: 6004

AN-04WFL

0.5-6 mm² Yüksük Sıkma Pensesi



69.00
USD

Sipariş Kodu: 6005

AN-006

0.5-6 mm² İzoleli Kablo Ucu Sıkma Pensesi



70.00
USD

Sipariş Kodu: 6006

AN-10

1.5-10 mm² İzolesiz Kablo Ucu Sıkma Pensesi



65.00
USD

Sipariş Kodu: 6007

AP-006

0.5-6 mm² İzoleli Kablo Ucu Sıkma Pensesi



71.00
USD

Sipariş Kodu: 6008

AN-16WF

1-16 mm² İzoleli Kablo Ucu Sıkma Pensesi



65.00
USD

Sipariş Kodu: 6009

AN-35WF

10-35 mm² İzoleli Kablo Ucu Sıkma Pensesi



68.00
USD

Sipariş Kodu: 6010

HSC8 6-4A

0.25-6 mm² İzoleli Kablo Ucu Sıkma Pensesi



89.00
USD

Sipariş Kodu: 6011

HSC8 6-6

0.25-6 mm² İzoleli Kablo Ucu Sıkma Pensesi



100.00
USD

Sipariş Kodu: 6012

HSC8 16-4

4-16 mm² İzoleli Kablo Ucu Sıkma Pensesi



100.00
USD

KABLO SIYIRICILARI / MEKANİK EL ALETLERİ

Sipariş Kodu: 6013

HS-2204

Kablo Sıyırıcı

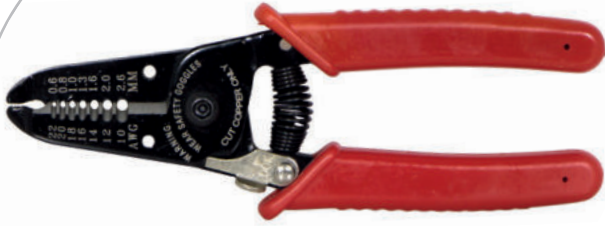

25.00
USD

Sipariş Kodu: 6014

ST700D

Kablo Sıyırıcı



33.00
USD

Sipariş Kodu: 6015

HY-369A

0.5-2 mm² Tekli Kablo Sıyırma Pensesi



37.00
USD

Sipariş Kodu: 6016

HY-369B

1.0-3.2 mm² Tekli Kablo Sıyırma Pensesi

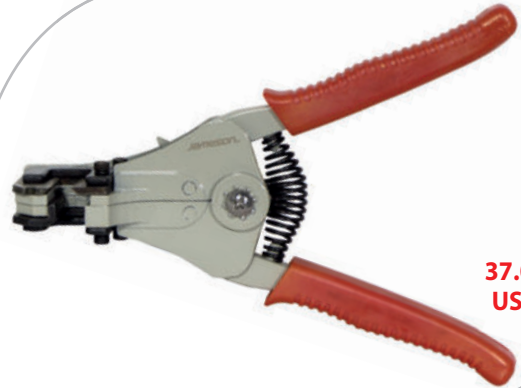

37.00
USD

Sipariş Kodu: 6017

G-2096C

6 PIN Konnektör Sıkma Pensesi



46.00
USD

Sipariş Kodu: 6018

HT-210C

8 PIN Konnektör Sıkma Pensesi



46.00
USD

Sipariş Kodu: 6019

JEA-CT468ST

4-6-8 (Testli) Konnektör Sıkma Pensesi



YENİ
ÜRÜN



99.00
USD

Sipariş Kodu: 6020

G-376E

6-8 PIN Konnektör Sıkma Pensesi



63.00
USD

Sipariş Kodu:7753

JEA-ST766K

Kablo Sıyırıcı ve Yüzük Sıkma Pensesi



60.00
USD

Sipariş Kodu:7754

JEA-ST766S

Kablo Sıyırıcı ve Yüzük Sıkma Pensesi



60.00
USD

Sipariş Kodu:7755

PT3141

Telefon Krone Kep Kep Pense



8,50
USD

Sipariş Kodu:7756

JEA-CT315

6-8 PIN Konnektör Sıkma Pensesi



56.00
USD

KABLO KESME MAKASLARI

Sipariş Kodu: 6022

TC-100120 mm² Kablo Kesme Makası**72.00
USD**

Sipariş Kodu: 6023

TC-250250 mm² Kablo Kesme Makası**135.00
USD**

Sipariş Kodu: 6025

TC-500630 mm² Kablo Kesme Makası**195.00
USD**

Sipariş Kodu: 6029

LK-22A22 - 160 mm² Kablo Kesme Makası**34.00
USD**

Sipariş Kodu: 6028

LK-38A38- 210 mm² Kablo Kesme Makası**38.00
USD**

Sipariş Kodu: 6027

LK-60A60 - 230 mm² Kablo Kesme Makası**43.00
USD**

KABLO PABUCU MEKANİK VE HİDROLİK SIKMA PENSELERİ

Sipariş Kodu: 6031

JY-0650

6 - 50 mm² SKP Sıkma Pensesi



82.00
USD

Sipariş Kodu: 6032

JY-06120

0.6 - 120 mm² SKP Sıkma Pensesi



165.00
USD

Sipariş Kodu: 6033

JY-25150

25 - 150 mm² SKP Sıkma Pensesi



170.00
USD

Sipariş Kodu: 6034

YQK-120

10 - 120 mm² Hidrolik SKP Sıkma Pensesi (Çantalı Set)



150.00
USD

Sipariş Kodu: 6035

YQK-300

16 - 300 mm² Hidrolik SKP Sıkma Pensesi (Çantalı Set)



160.00
USD

Sipariş Kodu: 6036

YQK-70

10 - 70 mm² Hidrolik SKP Sıkma Pensesi (Çantalı Set)



120.00
USD

KABLO KESME MAKASLARI

Sipariş Kodu: 6026

TCR-325

325 mm² Bakır ve Alüminyum Kablo Kesme Makası



195.00
USD

Sipariş Kodu: 6024

ZC-52A

500 mm² Çok Telli Kablo Kesme Makası



325.00
USD

Sipariş Kodu: 6030

ZC-60A

500 mm² Bakır ve Alüminyum Kablo Kesme Makası



240.00
USD

Sipariş Kodu: 6039

AN-103

1.0-6 mm² Kablo Kapama Pensesi



66.00
USD

Sipariş Kodu: 6040

HD-50L

5.5 - 50 mm² Yüksük Sıkma Pensesi



95.00
USD

Sipariş Kodu: 6041

T03C-5D

AN-04WFL Yüksük Sıkma 0.5 - 6 mm
AN-16WF Yüksük Sıkma 6 - 16 mm
AN-006 Kablo Ucu Sıkma 0.5 - 6 mm
AN-03B İzolesiz Terminal Sıkma 1 - 4 mm
AN-004 Kaynaklı Papuç Sıkma 0.5 - 10 mm

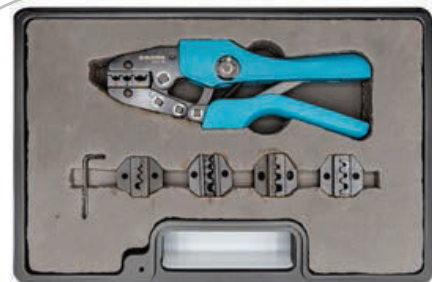

160.00
USD



Jameson®

BUTON SERİSİ VE AKSESUARLARI

www.kivilcimelektrik.com.tr

Ø 22mm BUTON SERİSİ YAYLI BUTONLAR

| Sipariş Kodu | Ürün Kodu | Kontak | Açıklama | Renk | Kutu Adet | Koli Adet | Fiyat TL. / AD. |
|--------------|----------------|--------|-------------|---------|-----------|-----------|-----------------|
| 7001 | A1 - 10 | 1NO | Yaylı Buton | Yeşil | 10 | 300 | 50.50 |
| 7002 | A1 - 01 | 1NC | Yaylı Buton | Kırmızı | 10 | 300 | 50.50 |
| 7003 | A1 - 11 | 1NO | Yaylı Buton | Sarı | 10 | 300 | 50.50 |
| 7004 | A1 - 21 | 1NO | Yaylı Buton | Mavi | 10 | 300 | 50.50 |
| 7005 | A1 - 31 | 1NO | Yaylı Buton | Beyaz | 10 | 300 | 50.50 |
| 7006 | A1 - 41 | 1NO | Yaylı Buton | Siyah | 10 | 300 | 50.50 |



İŞARETLİ YAYLI BUTONLAR

| | | | | | | | |
|------|------------------|-----|------------------------|---|----|-----|-------|
| 7007 | A1 - 10/1 | 1NO | İşaretlili Yaylı Buton | İ | 10 | 300 | 57.75 |
| 7008 | A1 - 01/2 | 1NC | İşaretlili Yaylı Buton | İ | 10 | 300 | 57.75 |
| 7009 | A1 - 10/3 | 1NO | İşaretlili Yaylı Buton | İ | 10 | 300 | 57.75 |
| 7010 | A1 - 10/4 | 1NO | İşaretlili Yaylı Buton | İ | 10 | 300 | 57.75 |



İŞIKLI YAYLI BUTONLAR

| | | | | | | | |
|------|-----------------------|-----|----------------------------------|---------|----|-----|-------|
| 7011 | A1 - 10D | 1NO | Işıklı Yaylı Buton 220V AC/DC | Yeşil | 10 | 300 | 93.00 |
| 7012 | A1 - 01D | 1NC | | Kırmızı | 10 | 300 | 93.00 |
| 7013 | A1 - 11D | 1NO | | Sarı | 10 | 300 | 93.00 |
| 7014 | A1 - 21D | 1NO | | Mavi | 10 | 300 | 93.00 |
| 7015 | A1 - 31D | 1NO | | Beyaz | 10 | 300 | 93.00 |
| 7016 | A1 - 10D - 110 | 1NO | Işıklı Yaylı Buton 110V AC/DC | Yeşil | 10 | 300 | 93.00 |
| 7017 | A1 - 01D - 110 | 1NC | | Kırmızı | 10 | 300 | 93.00 |
| 7018 | A1 - 11D - 110 | 1NO | | Sarı | 10 | 300 | 93.00 |
| 7019 | A1 - 21D - 110 | 1NO | | Mavi | 10 | 300 | 93.00 |
| 7020 | A1 - 31D - 110 | 1NO | | Beyaz | 10 | 300 | 93.00 |
| 7021 | A1 - 10D - 24 | 1NO | Işıklı Yaylı Buton 24V AC/DC | Yeşil | 10 | 300 | 93.00 |
| 7022 | A1 - 01D - 24 | 1NC | | Kırmızı | 10 | 300 | 93.00 |
| 7023 | A1 - 11D - 24 | 1NO | | Sarı | 10 | 300 | 93.00 |
| 7024 | A1 - 21D - 24 | 1NO | | Mavi | 10 | 300 | 93.00 |
| 7025 | A1 - 31D - 24 | 1NO | | Beyaz | 10 | 300 | 93.00 |



İKİZ BUTONLAR

| | | | | | | | |
|------|------------------------|-----------|----------------------------------|-----------------|----|-----|--------|
| 7026 | A1 - 11R | 1NO + 1NC | İkiz Buton | Yeşil - Kırmızı | 10 | 300 | 95.00 |
| 7027 | A1 - 11RD | 1NO + 1NC | Işıklı İkiz Buton 220 V AC/DC | Yeşil - Kırmızı | 10 | 300 | 131.30 |
| 7028 | A1 - 11RD - 110 | 1NO + 1NC | Işıklı İkiz Buton 110 V AC/DC | Yeşil - Kırmızı | 10 | 300 | 131.30 |
| 7029 | A1 - 11RD - 24 | 1NO + 1NC | Işıklı İkiz Buton 24 V AC/DC | Yeşil - Kırmızı | 10 | 300 | 131.30 |



Ø 22mm BUTON SERİSİ KALICI MANDAL BUTONLAR

| Sipariş Kodu | Ürün Kodu | Kontakt | Açıklama | Kutu Adet | Koli Adet | Fiyat TL. / AD. |
|--------------|------------------|---------|--|-----------|-----------|-----------------|
| 7030 | A1 - 10X | 1NO | 0-1 Mandal Buton  | 10 | 300 | 57.85 |
| 7031 | A1 - 20XS | 2NO | 1-0-2 Mandal Buton  | 10 | 300 | 76.30 |



KAYICI MANDAL BUTONLAR

| Sipariş Kodu | Ürün Kodu | Kontakt | Açıklama | Kutu Adet | Koli Adet | Fiyat TL. / AD. |
|--------------|-----------------------|---------|--|-----------|-----------|-----------------|
| 7032 | A1 - 10X / FU | 1NO | 0-1 Mandal Buton  | 10 | 300 | 61.50 |
| 7033 | A1 - 20XS / FU | 2NO | 1-0-2 Mandal Buton  | 10 | 300 | 82.65 |



ANAHTARLI KALICI & KAYICI BUTONLAR

| Sipariş Kodu | Ürün Kodu | Kontakt | Açıklama | Kutu Adet | Koli Adet | Fiyat TL. / AD. |
|--------------|----------------------|---------|---|-----------|-----------|-----------------|
| 7034 | A1 - 10Y | 1NO | 0-1 Anahtarlı Buton  | 10 | 300 | 82.65 |
| 7035 | A1 - 10Y / FU | 1NO | 0-1 Anahtarlı Buton  | 10 | 300 | 88.00 |
| 7744 | A1 - 20YS | 2NO | 1-0-2 Anahtarlı Buton  | 10 | 300 | 101.75 |



Ø 22mm BUTON SERİSİ KALICI - KAYICI MANDAL BUTON

| Sipariş Kodu | Ürün Kodu | Açıklama | Kutu Adet | Koli Adet | Fiyat TL. / AD. |
|--------------|------------------|--|-----------|-----------|-----------------|
| 7072 | A1-20XS/F | 1-0-2 Mandal Buton Sağ Pozisyon Kalıcı Sol Pozisyon Kayıcı  | 10 | 300 | 84.75 |









JOYSTICK VİNÇ BUTONLAR KALICI VE KAYICI

| Sipariş Kodu | Ürün Kodu | Açıklama | Kutu Adet | Koli Adet | Fiyat TL. / AD. |
|--------------|-------------------|------------------------|-----------|-----------|-----------------|
| 7036 | LA155-PA12 | 2 YÖNLÜ KALICI JOYSTİK | 10 | 300 | 188.00 |
| 7037 | LA155-PA14 | 4 YÖNLÜ KALICI JOYSTİK | 10 | 300 | 217.00 |
| 7073 | LA155-PA22 | 2 YÖNLÜ KAYICI JOYSTİK | 10 | 300 | 188.00 |
| 7074 | LA155-PA24 | 4 YÖNLÜ KAYICI JOYSTİK | 10 | 300 | 217.00 |



Ø 22mm BUTON SERİSİ IŞIKLI KALICI MANDAL BUTONLAR

| Sipariş Kodu | Ürün Kodu | Kontakt | Açıklama | Renk | Kutu Adet | Koli Adet | Fiyat TL. / AD. |
|--------------|-------------------------|---------|---|---------|-----------|-----------|-----------------|
| 7038 | A1 - 10XD | 1NO |  <p>0-1 Işıklı Mandal Buton 220V AC/DC</p> | Yeşil | 10 | 300 | 92.00 |
| 7039 | A1 - 01XD | 1NC | | Kırmızı | 10 | 300 | 92.00 |
| 7040 | A1 - 11XD | 1NO | | Sarı | 10 | 300 | 92.00 |
| 7041 | A1 - 21XD | 1NO | | Mavi | 10 | 300 | 92.00 |
| 7042 | A1 - 10XD - 110 | 1NO |  <p>0-1 Işıklı Mandal Buton 110V AC/DC</p> | Yeşil | 10 | 300 | 92.00 |
| 7043 | A1 - 01XD - 110 | 1NC | | Kırmızı | 10 | 300 | 92.00 |
| 7044 | A1 - 11XD - 110 | 1NO | | Sarı | 10 | 300 | 92.00 |
| 7046 | A1 - 21XD - 110 | 1NO | | Mavi | 10 | 300 | 92.00 |
| 7047 | A1 - 10XD - 24 | 1NO |  <p>0-1 Işıklı Mandal Buton 24V AC/DC</p> | Yeşil | 10 | 300 | 92.00 |
| 7048 | A1 - 01XD - 24 | 1NC | | Kırmızı | 10 | 300 | 92.00 |
| 7049 | A1 - 21XD - 24 | 1NO | | Sarı | 10 | 300 | 92.00 |
| 7050 | A1 - 31XD - 24 | 1NO | | Mavi | 10 | 300 | 92.00 |
| 7051 | A1 - 20XSD | 2NO |  <p>1-0-2 Işıklı Mandal Buton 220V AC/DC</p> | Yeşil | 10 | 300 | 112.00 |
| 7052 | A1 - 02XSD | 2NC | | Kırmızı | 10 | 300 | 112.00 |
| 7053 | A1 - 21XSD | 2NO | | Sarı | 10 | 300 | 112.00 |
| 7054 | A1 - 31XSD | 2NO | | Mavi | 10 | 300 | 112.00 |
| 7055 | A1 - 20XSD - 110 | 2NO |  <p>1-0-2 Işıklı Mandal Buton 110V AC/DC</p> | Yeşil | 10 | 300 | 112.00 |
| 7056 | A1 - 02XSD - 110 | 2NC | | Kırmızı | 10 | 300 | 112.00 |
| 7057 | A1 - 21XSD - 110 | 2NO | | Sarı | 10 | 300 | 112.00 |
| 7058 | A1 - 31XSD - 110 | 2NO | | Mavi | 10 | 300 | 112.00 |
| 7059 | A1 - 20XSD - 24 | 2NO |  <p>1-0-2 Işıklı Mandal Buton 24V AC/DC</p> | Yeşil | 10 | 300 | 112.00 |
| 7060 | A1 - 02XSD - 24 | 2NC | | Kırmızı | 10 | 300 | 112.00 |
| 7061 | A1 - 21XSD - 24 | 2NO | | Sarı | 10 | 300 | 112.00 |
| 7062 | A1 - 31XSD - 24 | 2NO | | Mavi | 10 | 300 | 112.00 |



Ø 22mm BUTON SERİSİ 40 mm KALICI MANTAR BUTON

| Sipariş Kodu | Ürün Kodu | Kontak | Açıklama | Renk | Kutu Adet | Koli Adet | Fiyat TL. / AD. |
|--------------|------------------|--------|--------------------|-----------|-----------|-----------|-----------------|
| 7063 | A1 - 01ZS | 1NC | Stop Mantar Button | ● Kırmızı | 10 | 300 | 66.50 |



40 mm KALICI ANAHTARLI MANTAR BUTON

| Sipariş Kodu | Ürün Kodu | Kontak | Açıklama | Renk | Kutu Adet | Koli Adet | Fiyat TL. / AD. |
|--------------|------------------|--------|------------------------------|-----------|-----------|-----------|-----------------|
| 7064 | A1 - 01ZA | 1NC | Anahtarlı Stop Mantar Button | ● Kırmızı | 10 | 300 | 85.00 |



40mm KAYICI MANTAR BUTONLAR

| Sipariş Kodu | Ürün Kodu | Kontak | Açıklama | Renk | Kutu Adet | Koli Adet | Fiyat TL. / AD. |
|--------------|-----------------|--------|-------------------|-----------|-----------|-----------|-----------------|
| 7065 | A1 - 01M | 1NC | Stop Mantar Buton | ● Kırmızı | 10 | 300 | 56.00 |
| 7066 | A1 - 10M | 1NO | Stop Mantar Buton | ● Yeşil | 10 | 300 | 56.00 |
| 7067 | A1 - 41M | 1NO | Stop Mantar Buton | ● Siyah | 10 | 300 | 56.00 |



40mm KALICI MANTAR BUTONLAR

| Sipariş Kodu | Ürün Kodu | Kontak | Açıklama | Renk | Kutu Adet | Koli Adet | Fiyat TL. / AD. |
|--------------|-------------------------|--------|---|--------|-----------|-----------|-----------------|
| 7075 | A1 - 01ZF | 1NC | Stop Mantar Buton | ● STOP | 10 | 300 | 116.50 |
| 7069 | A1 - 01ZFD | 1NC | Led Işıklı Stop Mantar Buton 220V AC/DC | ● STOP | 10 | 300 | 148.00 |
| 7070 | A1 - 01ZFD - 110 | 1NC | Led Işıklı Stop Mantar Buton 110V AC/DC | ● STOP | 10 | 300 | 148.00 |
| 7071 | A1 - 01ZFD - 24 | 1NC | Led Işıklı Stop Mantar Buton 24V AC/DC | ● STOP | 10 | 300 | 148.00 |



Ø 22mm BUTON SERİSİ BUTON AKSESUARLARI

| Sipariş Kodu | Ürün Kodu | Açıklama | Kutu Adet | Fiyat TL. / AD. |
|--------------|------------|-------------------------------------|-----------|-----------------|
| 7101 | A - 10 | 1NO Start Kontak | 50 | 21.00 |
| 7102 | A- 01 | 1NC Stop Kontak | 50 | 21.00 |
| 7103 | A - D2 | BA9S Led Kontak Yuvası (Buton için) | 200 | 25.20 |
| 7104 | XB2-EH2201 | Plastik Buton Rozeti | 100 | 3.10 |
| 7105 | XB2-EH2208 | Plastik Buton Rozeti | 100 | 3.10 |
| 7106 | XB2-ER60 | 60mm Acil Stop Etiketi | 100 | 9.35 |
| 7107 | XB2-EC2 | Acil Stop Butonu Koruma Kapağı | 20 | 50.00 |
| 7108 | XB2-EB40P | Buton Koruma Kapağı | 5 | 42.00 |
| 7109 | XB2-PE16A | Buton Koruma Kılıfı | 100 | 6.70 |
| 7110 | XB2-EC3 | Acil Stop Butonu Koruma Kapağı | 10 | 49.00 |
| 7111 | XB2-PE22CF | İkiz Buton Koruma Kılıfı | 100 | 22.00 |



BOŞ BUTON KUTULARI

| Sipariş Kodu | Ürün Kodu | Açıklama | Renk | Kutu Adet | Koli Adet | Fiyat TL. / AD. |
|--------------|------------|-------------------------|--------------|-----------|-----------|-----------------|
| 7201 | JBK 1 - SR | 1'li Boş Kumanda Kutusu | Sarı - Siyah | 1 | 100 | 33.50 |
| 7202 | JBK 1 - GR | 1'li Boş Kumanda Kutusu | Gri - Siyah | 1 | 100 | 33.50 |
| 7203 | JBK 2 - SR | 2'li Boş Kumanda Kutusu | Sarı - Siyah | 1 | 100 | 42.00 |
| 7204 | JBK 2 - GR | 2'li Boş Kumanda Kutusu | Gri - Siyah | 1 | 100 | 42.00 |
| 7205 | JBK 3 - SR | 3'li Boş Kumanda Kutusu | Sarı - Siyah | 1 | 100 | 53.90 |
| 7206 | JBK 3 - GR | 3'li Boş Kumanda Kutusu | Gri - Siyah | 1 | 100 | 53.90 |
| 7207 | JBK 4 - SR | 4'lü Boş Kumanda Kutusu | Sarı - Siyah | 1 | 50 | 68.55 |
| 7208 | JBK 4 - GR | 4'lü Boş Kumanda Kutusu | Gri - Siyah | 1 | 50 | 68.55 |
| 7209 | JBK 5 - SR | 5'li Boş Kumanda Kutusu | Sarı - Siyah | 1 | 50 | 100.80 |
| 7210 | JBK 5 - GR | 5'li Boş Kumanda Kutusu | Gri - Siyah | 1 | 50 | 100.80 |
| 7211 | JBK 6 - SR | 6'lı Boş Kumanda Kutusu | Sarı - Siyah | 1 | 50 | 100.80 |
| 7212 | JBK 6 - GR | 6'lı Boş Kumanda Kutusu | Gri - Siyah | 1 | 50 | 100.80 |



KUTULU ACİL STOP BUTON

| Sipariş Kodu | Ürün Kodu | Kontakt | Açıklama | Renk | Kutu Adet | Koli Adet | Fiyat TL. / AD. |
|--------------|-----------|---------|-----------------------------|--------------|-----------|-----------|-----------------|
| 7213 | JK-ASB | NC | 1'li Mantar Acil Stop Buton | Sarı - Siyah | 1 | 100 | 86.15 |



Ø 22mm VOLTMETRE

| Sipariş Kodu | Ürün Kodu | Çap (mm) | Açıklama | Renk | Kutu Adet | Koli Adet | Fiyat TL. / AD. |
|--------------|-----------------------|----------|--------------------------|-----------|-----------|-----------|-----------------|
| 7301 | AD-136-22DSV-K | 22 | 24-550V Led'li Voltmetre | ● Kırmızı | 10 | 500 | 82.00 |
| 7302 | AD-136-22DSV-Y | 22 | 24-550V Led'li Voltmetre | ● Yeşil | 10 | 500 | 82.00 |
| 7303 | AD-136-22DSV-S | 22 | 24-550V Led'li Voltmetre | ● Sarı | 10 | 500 | 82.00 |
| 7304 | AD-136-22DSV-M | 22 | 24-550V Led'li Voltmetre | ● Mavi | 10 | 500 | 82.00 |
| 7305 | AD-136-22DSV-B | 22 | 24-550V Led'li Voltmetre | ○ Beyaz | 10 | 500 | 82.00 |



Ø 22mm AMPERMETRE

| Sipariş Kodu | Ürün Kodu | Çap (mm) | Açıklama | Renk | Kutu Adet | Koli Adet | Fiyat TL. / Mt. |
|--------------|-----------------------|----------|---------------------------------------|-----------|-----------|-----------|-----------------|
| 7306 | AD-136-22DSA-K | 22 | 0-100A Led'li Ampermetre Akım Trafolu | ● Kırmızı | 5 | 300 | 153.00 |
| 7307 | AD-136-22DSA-Y | 22 | 0-100A Led'li Ampermetre Akım Trafolu | ● Yeşil | 5 | 300 | 153.00 |
| 7308 | AD-136-22DSA-S | 22 | 0-100A Led'li Ampermetre Akım Trafolu | ● Sarı | 5 | 300 | 153.00 |
| 7309 | AD-136-22DSA-M | 22 | 0-100A Led'li Ampermetre Akım Trafolu | ● Mavi | 5 | 300 | 153.00 |
| 7310 | AD-136-22DSA-B | 22 | 0-100A Led'li Ampermetre Akım Trafolu | ○ Beyaz | 5 | 300 | 153.00 |



Ø 22mm LED'Lİ SİNYALLER



| Sipariş Kodu | Ürün Kodu | Çap (mm) | Açıklama | Renk | Kutu Adet | Koli Adet | Fiyat TL. / AD. |
|--------------|-------------------------|----------|-----------------------|-----------|-----------|-----------|-----------------|
| 7311 | AD136-22DS-K | 22 | Led Sinyal 220V AC/DC | ● Kırmızı | 10 | 500 | 19.00 |
| 7312 | AD136-22DS-Y | 22 | Led Sinyal 220V AC/DC | ● Yeşil | 10 | 500 | 19.00 |
| 7313 | AD136-22DS-S | 22 | Led Sinyal 220V AC/DC | ● Sarı | 10 | 500 | 19.00 |
| 7314 | AD136-22DS-M | 22 | Led Sinyal 220V AC/DC | ● Mavi | 10 | 500 | 19.00 |
| 7315 | AD136-22DS-B | 22 | Led Sinyal 220V AC/DC | ○ Beyaz | 10 | 500 | 25.30 |
| 7316 | AD136-22DS-110-K | 22 | Led Sinyal 110V AC/DC | ● Kırmızı | 10 | 500 | 19.00 |
| 7317 | AD136-22DS-110-Y | 22 | Led Sinyal 110V AC/DC | ● Yeşil | 10 | 500 | 19.00 |
| 7318 | AD136-22DS-110-S | 22 | Led Sinyal 110V AC/DC | ● Sarı | 10 | 500 | 19.00 |
| 7319 | AD136-22DS-110-M | 22 | Led Sinyal 110V AC/DC | ● Mavi | 10 | 500 | 19.00 |
| 7320 | AD136-22DS-110-B | 22 | Led Sinyal 110V AC/DC | ○ Beyaz | 10 | 500 | 25.30 |
| 7321 | AD136-22DS-24-K | 22 | Led Sinyal 24V AC/DC | ● Kırmızı | 10 | 500 | 19.00 |
| 7322 | AD136-22DS-24-Y | 22 | Led Sinyal 24V AC/DC | ● Yeşil | 10 | 500 | 19.00 |
| 7323 | AD136-22DS-24-S | 22 | Led Sinyal 24V AC/DC | ● Sarı | 10 | 500 | 19.00 |
| 7324 | AD136-22DS-24-M | 22 | Led Sinyal 24V AC/DC | ● Mavi | 10 | 500 | 19.00 |
| 7325 | AD136-22DS-24-B | 22 | Led Sinyal 24V AC/DC | ○ Beyaz | 10 | 500 | 25.30 |

Ø 16mm LED'Lİ SİNYALLER

| Sipariş Kodu | Ürün Kodu | Çap (mm) | Açıklama | Renk | Kutu Adet | Koli Adet | Fiyat TL. / AD. |
|--------------|-------------------------|----------|-----------------------|-----------|-----------|-----------|-----------------|
| 7326 | AD136-16DS-K | 16 | Led Sinyal 220V AC/DC | ● Kırmızı | 20 | 1000 | 28.50 |
| 7327 | AD136-16DS-Y | 16 | Led Sinyal 220V AC/DC | ● Yeşil | 20 | 1000 | 28.50 |
| 7328 | AD136-16DS-S | 16 | Led Sinyal 220V AC/DC | ● Sarı | 20 | 1000 | 28.50 |
| 7329 | AD136-16DS-M | 16 | Led Sinyal 220V AC/DC | ● Mavi | 20 | 1000 | 28.50 |
| 7330 | AD136-16DS-B | 16 | Led Sinyal 220V AC/DC | ○ Beyaz | 20 | 1000 | 38.00 |
| 7331 | AD136-16DS-110-K | 16 | Led Sinyal 110V AC/DC | ● Kırmızı | 20 | 1000 | 28.50 |
| 7332 | AD136-16DS-110-Y | 16 | Led Sinyal 110V AC/DC | ● Yeşil | 20 | 1000 | 28.50 |
| 7333 | AD136-16DS-110-S | 16 | Led Sinyal 110V AC/DC | ● Sarı | 20 | 1000 | 28.50 |
| 7334 | AD136-16DS-110-M | 16 | Led Sinyal 110V AC/DC | ● Mavi | 20 | 1000 | 28.50 |
| 7335 | AD136-16DS-110-B | 16 | Led Sinyal 110V AC/DC | ○ Beyaz | 20 | 1000 | 38.00 |
| 7336 | AD136-16DS-24-K | 16 | Led Sinyal 24V AC/DC | ● Kırmızı | 20 | 1000 | 28.50 |
| 7337 | AD136-16DS-24-Y | 16 | Led Sinyal 24V AC/DC | ● Yeşil | 20 | 1000 | 28.50 |
| 7338 | AD136-16DS-24-S | 16 | Led Sinyal 24V AC/DC | ● Sarı | 20 | 1000 | 28.50 |
| 7339 | AD136-16DS-24-M | 16 | Led Sinyal 24V AC/DC | ● Mavi | 20 | 1000 | 28.50 |
| 7340 | AD136-16DS-24-B | 16 | Led Sinyal 24V AC/DC | ○ Beyaz | 20 | 1000 | 38.00 |



BA9S LED AMPULLER

| Sipariş Kodu | Ürün Kodu | Açıklama | Renk | Kutu Adet | Koli Adet | Fiyat TL. / AD. |
|--------------|-------------------------|----------------------|-----------|-----------|-----------|-----------------|
| 7341 | BA9SC - K | Led Ampul 220V AC/DC | ● Kırmızı | 50 | 4.000 | 26.35 |
| 7342 | BA9SC - Y | Led Ampul 220V AC/DC | ● Yeşil | 50 | 4.000 | 26.35 |
| 7343 | BA9SC - S | Led Ampul 220V AC/DC | ● Sarı | 50 | 4.000 | 26.35 |
| 7344 | BA9SC - M | Led Ampul 220V AC/DC | ● Mavi | 50 | 4.000 | 26.35 |
| 7345 | BA9SC - B | Led Ampul 220V AC/DC | ○ Beyaz | 50 | 4.000 | 31.60 |
| 7346 | BA9SC - 110V - K | Led Ampul 220V AC/DC | ● Kırmızı | 50 | 4.000 | 26.35 |
| 7347 | BA9SC - 110V - Y | Led Ampul 220V AC/DC | ● Yeşil | 50 | 4.000 | 26.35 |
| 7348 | BA9SC - 110V - S | Led Ampul 220V AC/DC | ● Sarı | 50 | 4.000 | 26.35 |
| 7349 | BA9SC - 110V - M | Led Ampul 220V AC/DC | ● Mavi | 50 | 4.000 | 26.35 |
| 7350 | BA9SC - 110V - B | Led Ampul 220V AC/DC | ○ Beyaz | 50 | 4.000 | 31.60 |
| 7351 | BA9SC - 24V - K | Led Ampul 220V AC/DC | ● Kırmızı | 50 | 4.000 | 26.35 |
| 7352 | BA9SC - 24V - Y | Led Ampul 220V AC/DC | ● Yeşil | 50 | 4.000 | 26.35 |
| 7353 | BA9SC - 24V - S | Led Ampul 220V AC/DC | ● Sarı | 50 | 4.000 | 26.35 |
| 7354 | BA9SC - 24V - M | Led Ampul 220V AC/DC | ● Mavi | 50 | 4.000 | 26.35 |
| 7355 | BA9SC - 24V - B | Led Ampul 220V AC/DC | ○ Beyaz | 50 | 4.000 | 31.60 |

METAL LEDLİ SİNYALLER



| Sipariş Kodu | Ürün Kodu | Çap (mm) | Açıklama | Renk | Kutu Adet | Koli Adet | Fiyat TL. / AD. |
|--------------|-------------------|----------|---------------------------------|-----------|-----------|-----------|-----------------|
| 7401 | J8-220-K | 8 | Metal Led Sinyal 220V. AC-DC | ● Kırmızı | 50 | 600 | 30.00 |
| 7402 | J8-220-Y | 8 | | ● Yeşil | 50 | 600 | 30.00 |
| 7403 | J8-220-SR | 8 | | ● Sarı | 50 | 600 | 30.00 |
| 7404 | J8-220-M | 8 | | ● Mavi | 50 | 600 | 30.00 |
| 7405 | J8-220-B | 8 | | ○ Beyaz | 50 | 600 | 35.00 |
| 7406 | J8-24-K | 8 | Metal Led Sinyal 24V. AC-DC | ● Kırmızı | 50 | 600 | 30.00 |
| 7407 | J8-24-Y | 8 | | ● Yeşil | 50 | 600 | 30.00 |
| 7408 | J8-24-SR | 8 | | ● Sarı | 50 | 600 | 30.00 |
| 7409 | J8-24-M | 8 | | ● Mavi | 50 | 600 | 30.00 |
| 7410 | J8-24-B | 8 | | ○ Beyaz | 50 | 600 | 35.00 |
| 7411 | J10-220-K | 10 | Metal Led Sinyal 220V. AC-DC | ● Kırmızı | 30 | 360 | 33.00 |
| 7412 | J10-220-Y | 10 | | ● Yeşil | 30 | 360 | 33.00 |
| 7413 | J10-220-SR | 10 | | ● Sarı | 30 | 360 | 33.00 |
| 7414 | J10-220-M | 10 | | ● Mavi | 30 | 360 | 33.00 |
| 7415 | J10-220-B | 10 | | ○ Beyaz | 30 | 360 | 40.00 |
| 7416 | J10-24-K | 10 | Metal Led Sinyal 24V. AC-DC | ● Kırmızı | 30 | 360 | 33.00 |
| 7417 | J10-24-Y | 10 | | ● Yeşil | 30 | 360 | 33.00 |
| 7418 | J10-24-SR | 10 | | ● Sarı | 30 | 360 | 33.00 |
| 7419 | J10-24-M | 10 | | ● Mavi | 30 | 360 | 33.00 |
| 7420 | J10-24-B | 10 | | ○ Beyaz | 30 | 360 | 40.00 |
| 7421 | J14-220-K | 14 | Metal Led Sinyal 220V. AC-DC | ● Kırmızı | 15 | 180 | 45.00 |
| 7422 | J14-220-Y | 14 | | ● Yeşil | 15 | 180 | 45.00 |
| 7423 | J14-220-SR | 14 | | ● Sarı | 15 | 180 | 45.00 |
| 7424 | J14-220-M | 14 | | ● Mavi | 15 | 180 | 45.00 |
| 7425 | J14-220-B | 14 | | ○ Beyaz | 15 | 180 | 48.00 |
| 7426 | J14-24-K | 14 | Metal Led Sinyal 24V. AC-DC | ● Kırmızı | 15 | 180 | 45.00 |
| 7427 | J14-24-Y | 14 | | ● Yeşil | 15 | 180 | 45.00 |
| 7428 | J14-24-SR | 14 | | ● Sarı | 15 | 180 | 45.00 |
| 7431 | J14-24-M | 14 | | ● Mavi | 15 | 180 | 45.00 |
| 7432 | J14-24-B | 14 | | ○ Beyaz | 15 | 180 | 48.00 |

BUZZERLAR Ø 22mm LEDLİ BUZZER



| Sipariş Kodu | Ürün Kodu | Çap (mm) | Açıklama | Renk | Kutu Adet | Koli Adet | Fiyat TL. / AD. |
|--------------|-------------------|----------|--|-----------|-----------|-----------|-----------------|
| 7433 | 22DS/MS | 22 | Sesli Led Flaşör İkazlı 220V. AC/DC | ● Kırmızı | 10 | 500 | 75.90 |
| 7434 | 22DS-MS110 | 22 | Sesli Led Flaşör İkazlı 110V. AC/DC | ● Kırmızı | 10 | 500 | 75.90 |
| 7435 | 22DS/MS24 | 22 | Sesli Led Flaşör İkazlı 24V. AC/DC | ● Kırmızı | 10 | 500 | 75.90 |
| 7451 | 22DS/MS12 | 22 | Sesli Led Flaşör İkazlı 12V. AC/DC | ● Kırmızı | 10 | 500 | 75.90 |

Ø 22mm SESLİ BUZZER



| Sipariş Kodu | Ürün Kodu | Çap (mm) | Açıklama | Renk | Kutu Adet | Koli Adet | Fiyat TL. / AD. |
|--------------|------------------|----------|--------------------------|---------|-----------|-----------|-----------------|
| 7436 | 22DS/M | 22 | Sesli İkazlı 220V. AC/DC | ● Siyah | 10 | 500 | 51.00 |
| 7437 | 22DS/M24 | 22 | Sesli İkazlı 24V. AC/DC | ● Siyah | 10 | 500 | 51.00 |
| 7438 | 22DS-M110 | 22 | Sesli İkazlı 110V. AC/DC | ● Siyah | 10 | 500 | 51.00 |

MOTORLU SİRENLER



| Sipariş Kodu | Ürün Kodu | Açıklama | Kutu Adet | Koli Adet | Fiyat TL. / AD. |
|--------------|--------------------|---|-----------|-----------|-----------------|
| 7439 | MS-190/220V | 75mm Metal Gövde 220V. AC (110 - 130dB) | 1 | 40 | 316.00 |
| 7440 | MS-190/24V | 75mm Metal Gövde 24V. AC (110 - 130dB) | 1 | 40 | 316.00 |
| 7441 | MS-290/220V | 110mm Metal Gövde 220AC (110-130dB) | 1 | 40 | 425.00 |
| 7442 | MS-290/24V | 110mm Metal Gövde 24V (110-130dB) | 1 | 40 | 425.00 |

ELEKTRONİK SİRENLER



| Sipariş Kodu | Ürün Kodu | Açıklama | Kutu Adet | Koli Adet | Fiyat TL. / AD. |
|--------------|--------------------|-----------------------------------|-----------|-----------|-----------------|
| 7443 | ES-50-12/24 | Plastik Gövde 120dB 12-24V. AC/DC | 1 | 100 | 144.00 |
| 7444 | ES-60-220 | Plastik Gövde 120dB 220V. AC | 1 | 100 | 235.00 |
| 7445 | ES-60-12/24 | Plastik Gövde 120dB 12-24V. AC | 1 | 100 | 235.00 |

Ø 22mm POTANSİYOMETRE



| Sipariş Kodu | Ürün Kodu | Çap (mm) | Açıklama | Kutu Adet | Koli Adet | Fiyat TL. / AD. |
|--------------|----------------|----------|---------------------------------------|-----------|-----------|-----------------|
| 7446 | JPT-5K | 22 | 5K Potansiyometre Tek Turlu 220V. AC | 10 | 500 | 126.00 |
| 7447 | JPT-10K | 22 | 10K Potansiyometre Tek Turlu 220V. AC | 10 | 500 | 126.00 |

PANO İÇİ TERMOSTATLAR



Çalışma Ömrü : 100.000 Açma Kapama

Ölçüler : 60x33x43

Ağırlık : 40 gr

Koruma Sınıfı : IP20

| Sipariş Kodu | Ürün Kodu | Kontakt | Açıklama | Kutu Adet | Koli Adet | Fiyat TL. / AD. |
|--------------|----------------|---------|---------------------------------|-----------|-----------|-----------------|
| 7448 | KTS-010 | NC | Isıtma Termostatı (0 - 60°C) | 1 | 300 | 153.00 |
| 7449 | KTS-011 | NO | Soğutma Termostatı (0 - 60°C) | 1 | 300 | 153.00 |
| 7450 | ZR-011 | NO | Soğuk-Sıcak Termostat (0-60 C) | 1 | 300 | 255.00 |

VİNÇ KUMANDA BUTONLARI PLASTİK VİNÇ KUMANDALAR (IP67)

| Sipariş Kodu | Ürün Kodu | Açıklama | Kutu Adet | Koli Adet | Fiyat USD / Ad. |
|--------------|---------------|-------------------------------------|-----------|-----------|-----------------|
| 7501 | VK - 2 | Plastik Vinç Kumanda 2'li Tek Hızlı | 1 | 72 | 5,80 |
| 7502 | VK - 4 | Plastik Vinç Kumanda 4'lü Tek Hızlı | 1 | 48 | 7,50 |
| 7503 | VK - 6 | Plastik Vinç Kumanda 6'lı Tek Hızlı | 1 | 42 | 10,00 |
| 7504 | VK - 8 | Plastik Vinç Kumanda 8'li Tek Hızlı | 1 | 36 | 13,00 |



ACİL STOPLU PLASTİK VİNÇ KUMANDALAR (IP67)

| Sipariş Kodu | Ürün Kodu | Açıklama | Kutu Adet | Koli Adet | Fiyat USD / Ad. |
|--------------|----------------|-------------------------------------|-----------|-----------|-----------------|
| 7505 | VKB - 3 | Plastik Vinç Kumanda 3'lü Tek Hızlı | 1 | 50 | 23,00 |
| 7506 | VKB - 5 | Plastik Vinç Kumanda 5'li Tek Hızlı | 1 | 40 | 32,00 |
| 7507 | VKB - 7 | Plastik Vinç Kumanda 7'li Tek Hızlı | 1 | 30 | 41,00 |
| 7508 | VKB - 9 | Plastik Vinç Kumanda 9'lü Tek Hızlı | 1 | 20 | 50,00 |



AYAK PEDALLARI

| | | |
|---------------------|--|--------------|
| BİRİM FİYAT USD/Ad. | 7.85 | 8.00 (metal) |
| SİPARİŞ KODU | 7601 | 7602 |
| ÜRÜN KODU | JP-1 | |
| KUTU ADEDİ | 1 | |
| KOLİ ADEDİ | 60 | |
| AÇIKLAMA | METAL DÖKÜM ve PLASTİK PEDAL 1 mt Kablolu | |

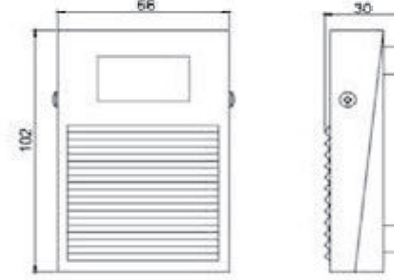

| | | |
|---------------------|---------------------------------------|--|
| BİRİM FİYAT USD/Ad. | 11.50 | |
| SİPARİŞ KODU | 7603 | |
| ÜRÜN KODU | JP-2 | |
| KUTU ADEDİ | 1 | |
| KOLİ ADEDİ | 60 | |
| AÇIKLAMA | ALÜMİNYUM DÖKÜM PEDAL 1 mt Kablolu | |

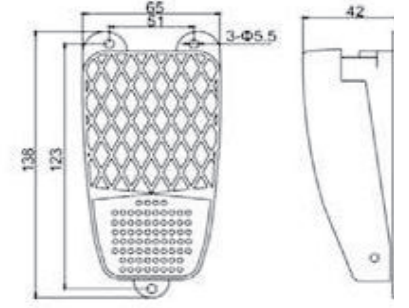

| | | |
|---------------------|---------------------------------------|--|
| BİRİM FİYAT USD/Ad. | 14.50 | |
| SİPARİŞ KODU | 7604 | |
| ÜRÜN KODU | JP-3 | |
| KUTU ADEDİ | 1 | |
| KOLİ ADEDİ | 40 | |
| AÇIKLAMA | ALÜMİNYUM DÖKÜM PEDAL 1 mt Kablolu | |

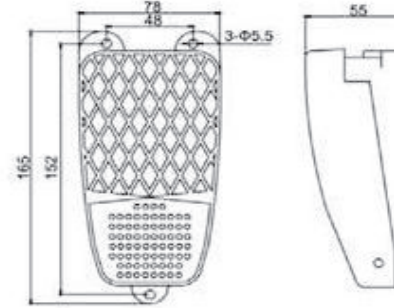

| | | |
|---------------------|-------------------|--|
| BİRİM FİYAT USD/Ad. | 37.00 | |
| SİPARİŞ KODU | 7605 | |
| ÜRÜN KODU | JP-9 | |
| KUTU ADEDİ | 1 | |
| KOLİ ADEDİ | 12 | |
| AÇIKLAMA | METAL DÖKÜM PEDAL | |

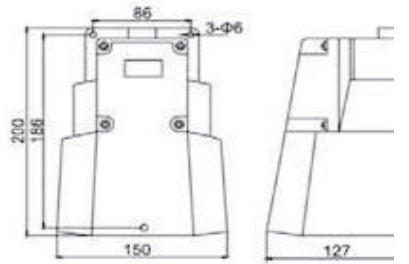



Jameson®

SWITCH FAN VE FİLTRE ÇEŞİTLERİ

www.kivilmielektrik.com.tr

JLS SERİSİ LİMİT SWITCH

| | |
|------------------------|---|
| BİRİM FİYAT USD/Ad. | 6.70 |
| SİPARİŞ KODU | 7701 |
| ÜRÜN KODU | JLS-101 |
| KUTU ADEDİ | 10 |
| KOLİ ADEDİ | 100 |
| AÇIKLAMA | Ayarlanabilir Metal Makaralı Çift Yön 1NO + 1 NC |

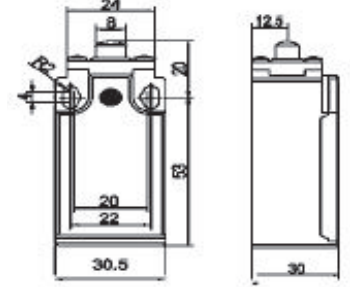

| | |
|------------------------|--|
| BİRİM FİYAT USD/Ad. | 6.70 |
| SİPARİŞ KODU | 7702 |
| ÜRÜN KODU | JLS-103 |
| KUTU ADEDİ | 10 |
| KOLİ ADEDİ | 100 |
| AÇIKLAMA | Dikey Metal Makaralı Resetli 1NO + 1 NC |

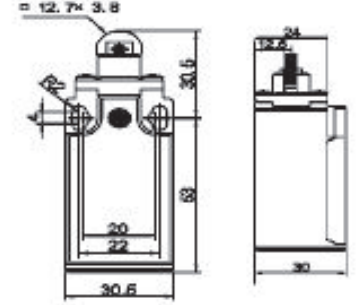

| | |
|------------------------|------------------------------------|
| BİRİM FİYAT USD/Ad. | 7.20 |
| SİPARİŞ KODU | 7703 |
| ÜRÜN KODU | JLS-103-R |
| KUTU ADEDİ | 10 |
| KOLİ ADEDİ | 100 |
| AÇIKLAMA | Kısa Dikey Metal Pim 1NO + 1 NC |

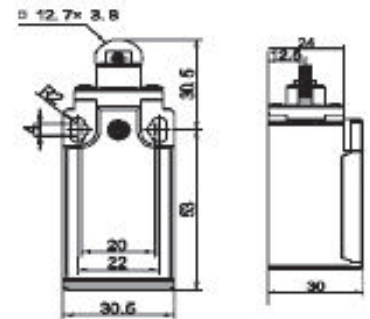

JLS SERİSİ LİMİT SWITCH

BİRİM FİYAT
USD/Ad. 6.70

SİPARİŞ KODU 7704

ÜRÜN KODU **JLS-111**

KUTU ADEDİ 10

KOLİ ADEDİ 100

AÇIKLAMA Açısal Metal Makaralı Tek Yön
1NO + 1 NC

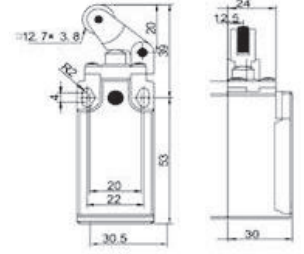

BİRİM FİYAT
USD/Ad. 6.70

SİPARİŞ KODU 7705

ÜRÜN KODU **JLS-121**

KUTU ADEDİ 10

KOLİ ADEDİ 100

AÇIKLAMA Dikey Metal Makaralı Çift Yön
1NO + 1 NC

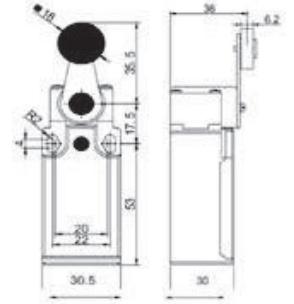

BİRİM FİYAT
USD/Ad. 6.70

SİPARİŞ KODU 7706

ÜRÜN KODU **JLS-127**

KUTU ADEDİ 10

KOLİ ADEDİ 100

AÇIKLAMA Ters Açısal Metal Makaralı Tek Yön
1NO + 1 NC

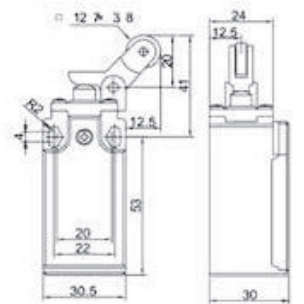

JLS SERİSİ LİMİT SWITCH

BİRİM FİYAT
USD/Ad. 7.10

SİPARİŞ KODU 7707

ÜRÜN KODU **JLS-131**

KUTU ADEDİ 10

KOLİ ADEDİ 100

AÇIKLAMA Ayarlanabilir Metal Makaralı
Çift Yön 1NO + 1 NC

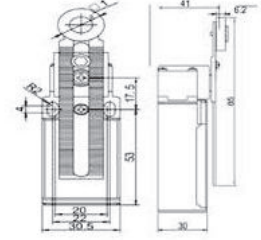

BİRİM FİYAT
USD/Ad. 7.00

SİPARİŞ KODU 7708

ÜRÜN KODU **JLS-161**

KUTU ADEDİ 10

KOLİ ADEDİ 100

AÇIKLAMA Çok Yönlü Spiral Tel Uç
1NO + 1 NC

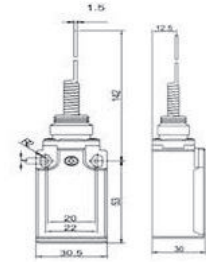

BİRİM FİYAT
USD/Ad. 7.00

SİPARİŞ KODU 7709

ÜRÜN KODU **JLS-171**

KUTU ADEDİ 10

KOLİ ADEDİ 100

AÇIKLAMA Çok Yönlü Spiral Plastik Uç
1NO + 1 NC

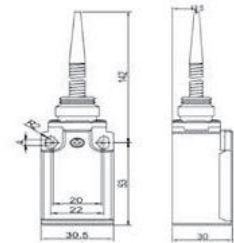

JLS SERİSİ LİMİT SWITCH

BİRİM FİYAT
USD/Ad. 7.00

SİPARİŞ KODU 7710

ÜRÜN KODU **JLS-191**

KUTU ADEDİ 10

KOLİ ADEDİ 100

AÇIKLAMA Ayarlanabilir Kauçuk Makara
Çift Yön 1NO + 1 NC

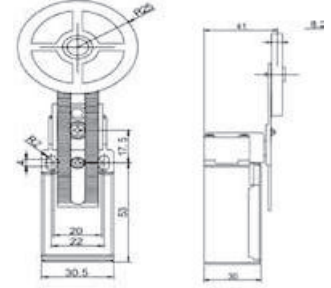

BİRİM FİYAT
USD/Ad. 8.80

SİPARİŞ KODU 7711

ÜRÜN KODU **JLS-191-R**

KUTU ADEDİ 10

KOLİ ADEDİ 100

AÇIKLAMA Ayarlanabilir Kauçuk Makara
Çift Yön 1NO + 1 NC

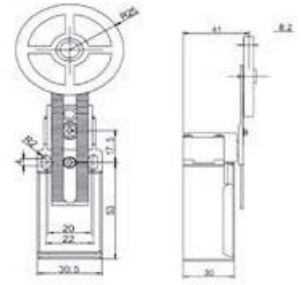

JMZ SERİSİ MİKRO SWITCH

| | |
|---------------------|-----------------------------------|
| BİRİM FİYAT USD/Ad. | 3.60 |
| SİPARİŞ KODU | 7712 |
| ÜRÜN KODU | JMZ-1300 |
| KUTU ADEDİ | 20 |
| KOLİ ADEDİ | 360 |
| AÇIKLAMA | İnce Kısa Pimli 15A 1NO + 1 NC |

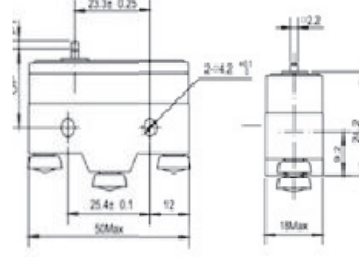

| | |
|---------------------|------------------------------------|
| BİRİM FİYAT USD/Ad. | 4.00 |
| SİPARİŞ KODU | 7713 |
| ÜRÜN KODU | JMZ-1306 |
| KUTU ADEDİ | 20 |
| KOLİ ADEDİ | 360 |
| AÇIKLAMA | Kalın Uzun Pimli 15A 1NO + 1 NC |

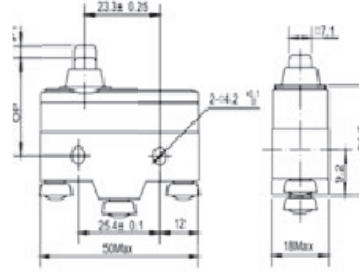

| | |
|---------------------|-----------------------------------|
| BİRİM FİYAT USD/Ad. | 4.60 |
| SİPARİŞ KODU | 7714 |
| ÜRÜN KODU | JMZ-1305 |
| KUTU ADEDİ | 20 |
| KOLİ ADEDİ | 360 |
| AÇIKLAMA | İnce Uzun Pimli 15A 1NO + 1 NC |

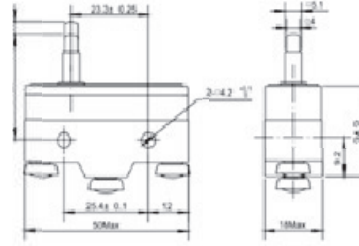

| | |
|---------------------|------------------------------|
| BİRİM FİYAT USD/Ad. | 4.00 |
| SİPARİŞ KODU | 7715 |
| ÜRÜN KODU | JMZ-1701 |
| KUTU ADEDİ | 20 |
| KOLİ ADEDİ | 360 |
| AÇIKLAMA | Uzun Palet 15A 1NO + 1 NC |

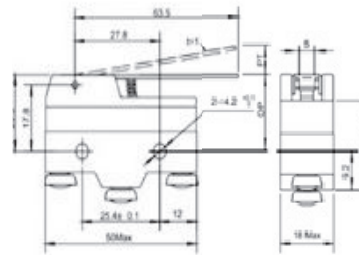

JMZ SERİSİ MİKRO SWITCH

| | |
|---------------------|---|
| BİRİM FİYAT USD/Ad. | 4.30 |
| SİPARİŞ KODU | 7716 |
| ÜRÜN KODU | JMZ-1703 |
| KUTU ADEDİ | 20 |
| KOLİ ADEDİ | 360 |
| AÇIKLAMA | Uzun Palet Metal Makaralı 15A 1NO + 1 NC |

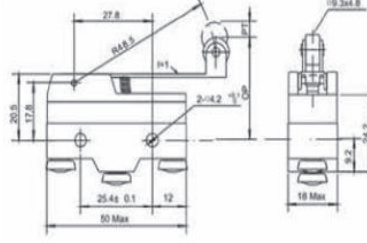

| | |
|---------------------|--------------------------------|
| BİRİM FİYAT USD/Ad. | 4.00 |
| SİPARİŞ KODU | 7717 |
| ÜRÜN KODU | JMZ-1702 |
| KUTU ADEDİ | 20 |
| KOLİ ADEDİ | 360 |
| AÇIKLAMA | Kısa Paletli 15A 1NO + 1 NC |

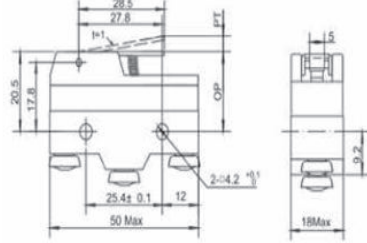

| | |
|---------------------|---------------------------------------|
| BİRİM FİYAT USD/Ad. | 4.30 |
| SİPARİŞ KODU | 7718 |
| ÜRÜN KODU | JMZ-1704 |
| KUTU ADEDİ | 20 |
| KOLİ ADEDİ | 360 |
| AÇIKLAMA | Kısa Metal Makaralı 15A 1NO + 1 NC |

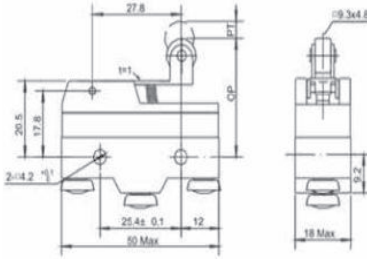

| | |
|---------------------|---|
| BİRİM FİYAT USD/Ad. | 4.80 |
| SİPARİŞ KODU | 7719 |
| ÜRÜN KODU | JMZ-1743 |
| KUTU ADEDİ | 20 |
| KOLİ ADEDİ | 360 |
| AÇIKLAMA | Tahrikli Metal Makaralı 15A 1NO + 1 NC |

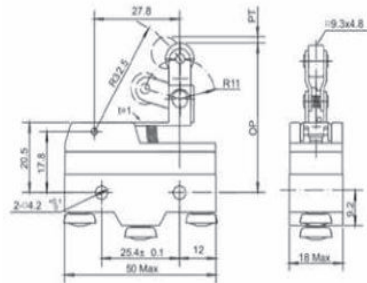

JMS SERİSİ MİKRO SWITCH

| | | | |
|---------------------|--------------------------------------|------------|-----------------|
| BİRİM FİYAT USD/Ad. | 1.23 | | |
| SİPARİŞ KODU | 7725 | ÜRÜN KODU | JMS-100C |
| KUTU ADEDİ | 100 | KOLİ ADEDİ | 1.800 |
| AÇIKLAMA | 100 Amper Plastik Pimli Mikro Switch | | |



| | | | |
|---------------------|-----------------------------------|------------|-----------------|
| BİRİM FİYAT USD/Ad. | 1.23 | | |
| SİPARİŞ KODU | 7726 | ÜRÜN KODU | JMS-101C |
| KUTU ADEDİ | 100 | KOLİ ADEDİ | 1.800 |
| AÇIKLAMA | 100 Amper Orta Kollu Mikro Switch | | |



| | | | |
|---------------------|-----------------------------------|------------|-----------------|
| BİRİM FİYAT USD/Ad. | 1.23 | | |
| SİPARİŞ KODU | 7727 | ÜRÜN KODU | JMS-102C |
| KUTU ADEDİ | 100 | KOLİ ADEDİ | 1.800 |
| AÇIKLAMA | 100 Amper Kısa Kollu Mikro Switch | | |



| | | | |
|---------------------|--|------------|-----------------|
| BİRİM FİYAT USD/Ad. | 1.37 | | |
| SİPARİŞ KODU | 7728 | ÜRÜN KODU | JMS-103C |
| KUTU ADEDİ | 100 | KOLİ ADEDİ | 1.800 |
| AÇIKLAMA | 100 Amper Uzun Kollu Metal Makaralı Mikro Switch | | |



| | | | |
|---------------------|--|------------|-----------------|
| BİRİM FİYAT USD/Ad. | 1.37 | | |
| SİPARİŞ KODU | 7729 | ÜRÜN KODU | JMS-104C |
| KUTU ADEDİ | 100 | KOLİ ADEDİ | 1.800 |
| AÇIKLAMA | 100 Amper Kısa Kollu Metal Makaralı Mikro Switch | | |



| | | | |
|---------------------|-----------------------------------|------------|-----------------|
| BİRİM FİYAT USD/Ad. | 1.37 | | |
| SİPARİŞ KODU | 7730 | ÜRÜN KODU | JMS-105C |
| KUTU ADEDİ | 100 | KOLİ ADEDİ | 1.800 |
| AÇIKLAMA | 100 Amper Uzun Kollu Mikro Switch | | |



| | | | |
|---------------------|-------------------------------------|------------|-----------------|
| BİRİM FİYAT USD/Ad. | 1.37 | | |
| SİPARİŞ KODU | 7731 | ÜRÜN KODU | JMS-106C |
| KUTU ADEDİ | 100 | KOLİ ADEDİ | 1.800 |
| AÇIKLAMA | 100 Amper Kıvrık Kollu Mikro Switch | | |



FANLAR

| ÜRÜN KODU | KUTU ADET | Birim Fiyat USD. |
|----------------------|-----------|------------------|
| JF-8025-24V | 50 | 6.75 |
| JF-8025-220V | 50 | 9.00 |
| JF-12025-24V | 40 | 6.00 |
| JF-12025-220V | 40 | 11.25 |
| JF-17050-24V | 25 | 42.00 |
| JF-17050-220V | 25 | 27.00 |
| JF-22580-220V | 10 | 109.5 |



FAN FİLTRELERİ

| ÜRÜN KODU | KUTU ADET | Birim Fiyat USD. |
|----------------|-----------|------------------|
| JF-107F | 120 | 6.00 |
| JF-148F | 60 | 6.15 |
| JF-205F | 40 | 8.25 |
| JF-255F | 30 | 22.50 |



FAN KORUMA TELLERİ

| ÜRÜN KODU | KUTU ADET | Birim Fiyat USD. |
|----------------|-----------|------------------|
| JF-80M | 500 | 1.02 |
| JF-120M | 200 | 1.08 |
| JF-170M | 100 | 1.5 |
| JF-225M | 50 | 12.75 |

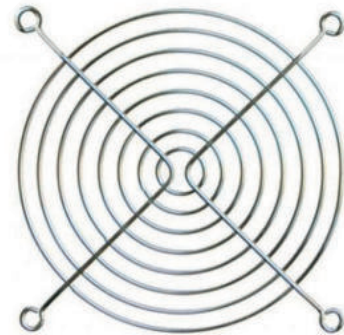



JAMESON®





Kivilcim Elektrik

Merkez
Hüseyin Okan Merzeci Mah.
Akbelen Bulvarı No: 179 / A
Toroslar / MERSİN

Tel: 0324 324 20 10

Whatsapp Sipariş Hattı: 
0531 727 74 64

www.kivilcimelektrik.com.tr